

Con Birr

Schaltet nach On in auf Stand by

Dual



VRC 840
BLG 840
NG 840



Service Schaltbilder
Circuit diagrams

Dual GmbH · Postfach 1144 · 7742 St. Georgen/Schwarzwald

920 880

Printed in Germany by Dual

Inhalt

	Seite
Ausbauhinweise	2
Abkürzungen	5
Verdrahtungsplan	7
Blockschaltbilder:	
Audio	9
Video (Farbsignal)	11
Video (Luminanzsignal)	13
Mechaniksteuerung	17
Mechaniksteuerung – Impulsdiagramm	21
Kopftrommelservo – Impulsdiagramm	23
Kopftrommelservo	25
Capstanservo	28
– Impulsdiagramme	31
Camera – Video	34
Schaltbilder und Platinen:	
Audio	37
Video (Recorder)-Platine	40
– Schaltbild	43
Servo-Schaltbild	47
– Platine (Mechacon)-Servo	51
– Platine (Audio)-Servo	70
– Spannungstabellen	57
Mechaniksteuerung – Schaltbild	65
– Platine	51
– Platine mit IC-Anschlüssen	55
Ablenk-Schaltbild	73
– Platine	75
Video (Camera)	78
– Platine	81
E-E und Anzeige	84
– Platine	87
Elektron. Sucher	89
– Platine	91
HF-Modulator	92
Netz- und Ladegerät	93
– Platine	95
Akku-Ladegerät	97
– Platine	99
Bordnetzkabel	100
– Platine	101

Index

	Page
Disassembly	2
Abbreviations	5
Wiring diagram	7
Block diagrams:	
Audio	9
Video (chroma signal)	11
Video (luminance signal)	13
Mechacon	17
Mechacon timing chart	21
Drum servo timing chart	23
Drum servo	25
Capstan servo	28
– timing charts	31
Camera video	34
Circuit diagrams and PWB:	
Audio	37
Video (tape recorder) PWB	40
– circuit diagram	43
Servo-circuit diagram	47
– PWB (Mechacon)-Servo	51
– PWB (Audio)-Servo	70
– Voltage tables	57
Mechacon – circuit diagram	65
– PWB	51
– PWB with IC pin location	55
Deflection + SSG-circuit diagram	73
– PWB	75
Video (camera)	78
– PWB	81
E-E and Indicator	84
– PWB	87
Electronic Viewfinder	89
– PWB	91
RF-Modulator	92
AC Power adapter + batt. charger	93
– PWB	95
Battery charger	97
– PWB	99
DC-DC Converter	100
– PWB	101

Ausbauhinweise

1. Gehäuse

- a) Zuerst die Blattfeder im Zubehörschuh anheben und herausziehen. 4 Schrauben [D] lösen und Zubehörschuh abnehmen.
- b) Deckplatte an den Punkten [E] anheben, um die Rastnasen zu lockern und dann in Pfeilrichtung [F] abziehen.

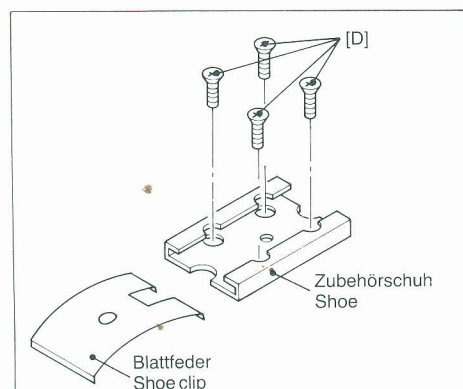

2. Gehäuse

2 Schrauben [G] und 4 Schrauben [H] herausdrehen, um die obere Gehäusehälfte von der unteren zu lösen.

Disassembly

1. Top plate

- a) First remove the shoe clip by raising the part upwards and pulling it to the front. Then remove the 4 screws [D].
- b) Raise the two parts [E] of the top plate to unfasten its claws and then slide it in the direction of [F]:

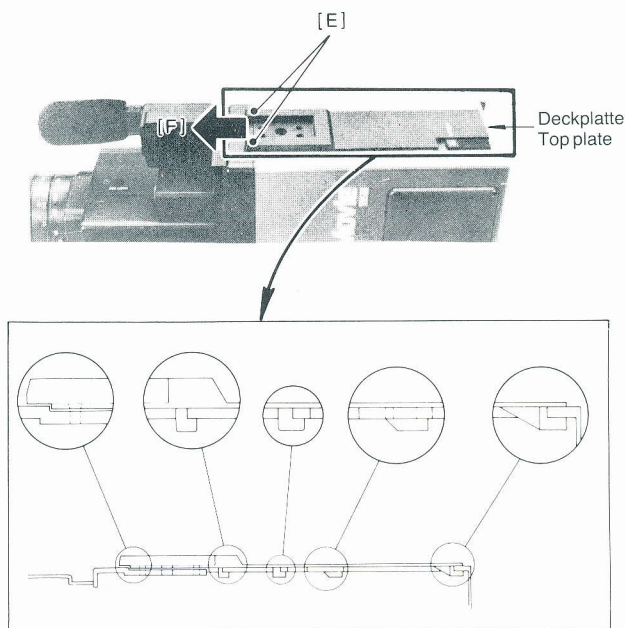

2. Housing

Remove the 2 screws [G] and 4 screws [H] to partially take off the upper case from the lower frame.

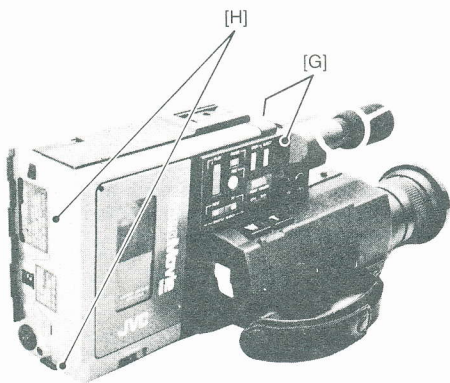

3. Cassettenfach-Abdeckung

2 Schrauben [I] lösen. Cassettenfach-Abdeckung in Pfeilrichtung [J] abziehen.

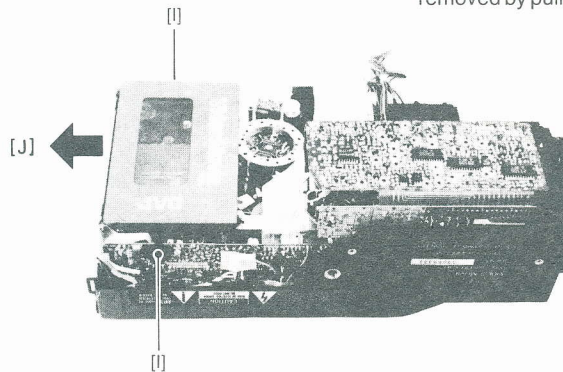

4. Camerateil

Zunächst 2 Schrauben [K] und 2 Schrauben [L] lösen. Schraube [M] lösen und die Platte für Taste Blendenfixierung in Pfeilrichtung abnehmen. Dann das Camerateil nach oben herausnehmen.

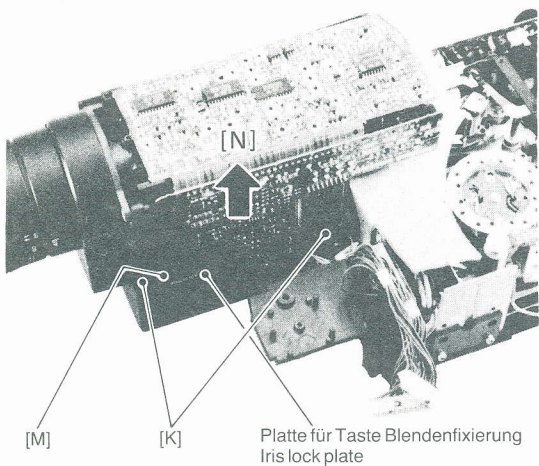

5. Recorderteil

Schraube [N] und Abschirmung entfernen. 3 Schrauben [O] lösen und das Recorderteil nach oben herausnehmen (Stecker [P] abziehen).

Hinweis: Das Recorderteil sehr vorsichtig herausnehmen, um freiliegende mechanische Teile nicht zu beschädigen.

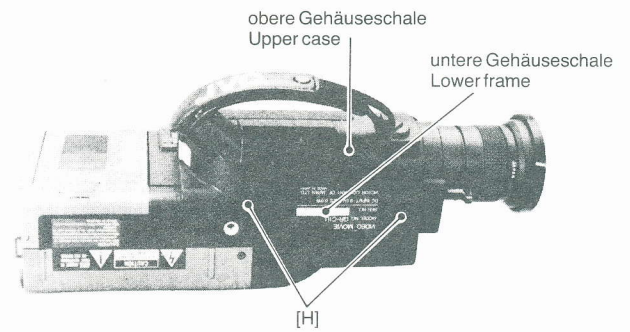
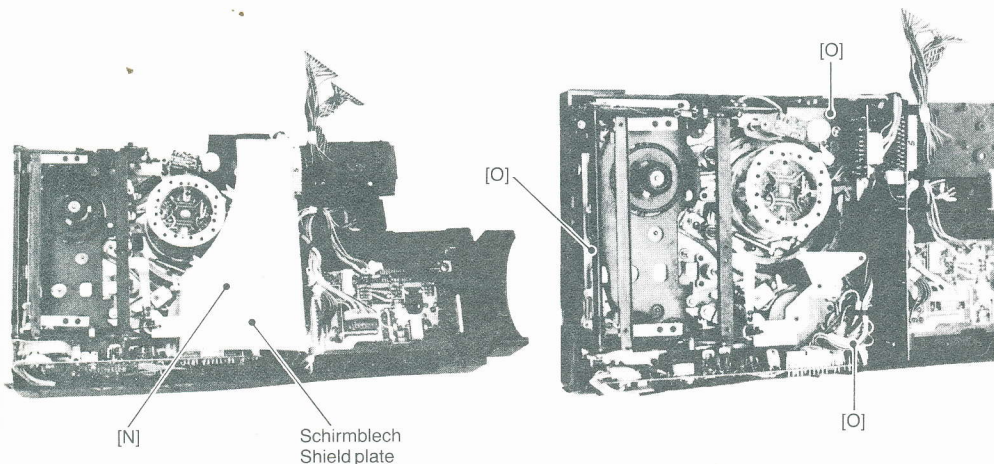

3. Cassette cover

Remove the two screws [I]. Then the cassette cover can be removed by pulling it in the direction of [J].

4. Camera portion

Remove the two screws [K] and two screw [L] first, and then remove a screw [M] to remove the iris lock plate by raising it upwards in the direction of [N]. After that, the camera can be removed by raising it upwards.

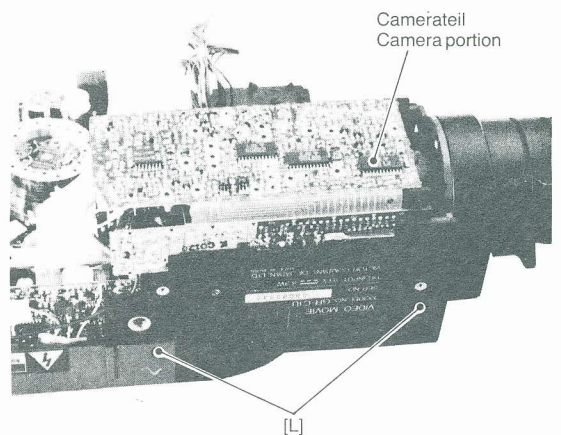

5. Tape recorder

Remove the screw [N] and the shield plate. Remove the 3 screws [O]. Then remove the deck by pulling it upwards. (Remove connector [P].)

Note: When removing the deck, pay the most careful attention not to touch the mechanism parts exposed.

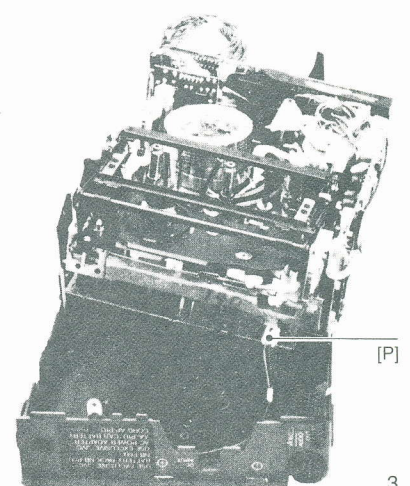

6. E-E und Anzeigenplatte [2] [3]

3 Schrauben [Q] lösen und die Schaltungsplatte herausklappen.

6. E-E and Indicator board [2] [3]

Remove the three screws [Q] so that the E-E & IND board can be opened to this side.

7. Audio-Servoplatte [0] [4]

7 Stecker [R] abziehen und die Audio/Servoplatte in Pfeilrichtung [S] abziehen. Stecker für den Audio-Kopf abnehmen.

7. Audio-Servo board [0] [4]

First remove the 7 connectors [R] and then remove the AUDIO/SERVO board by pulling it in the direction of the arrow [S]. Remove the connector for the audio head.

8. Videoplatte [0] [2]

nach oben abziehen.

8. Video board [0] [2]

Pull out in upwards direction.

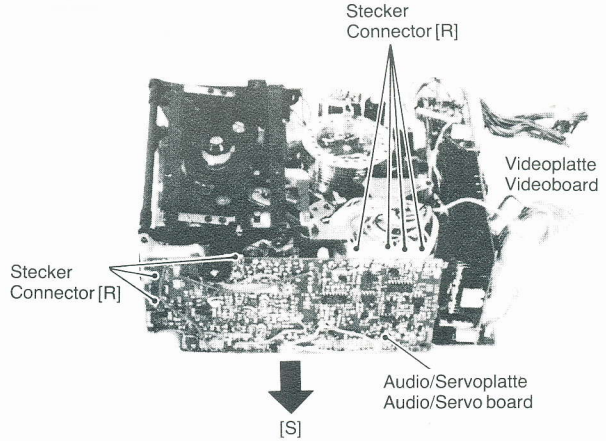
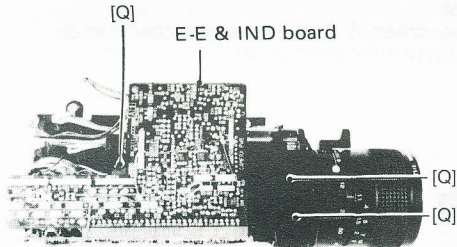

9. Platte für Servoregelung und Mechaniksteuerung [0] [1]

Eine Schraube [T] und 2 Stecker [U] entfernen und 3 Stecker [V] abziehen.

9. Mechacon/Servo board [0] [1]

Remove a screw [T] and the 2 connectors [U] to remove the MECHACON/SERVO board. Remove 3 connectors [V].

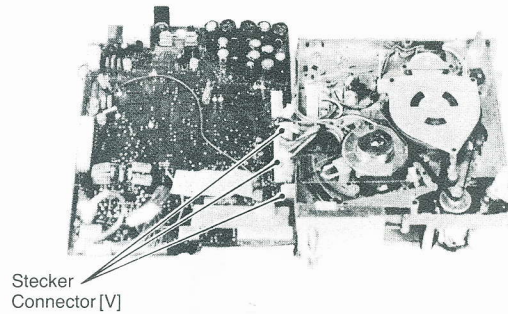
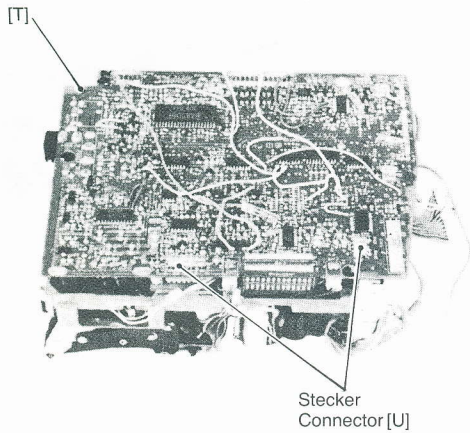

10. Videokopf-Vorverstärker

Abschirmung und Schraube [W] entfernen und 8 Kopftrommelzuleitungen ablöten.

10. Drum-Preampfier

Remove the cover of the shield case, a screw [W] and desolder the eight wires to the drum.

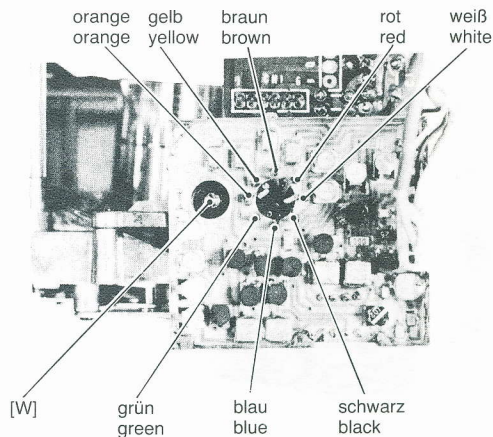

ID	Kennimpuls	Identification (Pulse)	RS FF	RS Flipflop	RS Flippflop
IF	ZF	Intermediate Frequency	RST	rücksetzen	Reset
IFR	Infrarot	Infrared	R/P	Aufnahme/Wiedergabe	Record/Playback
IFT	ZF-Übertrager	Intermediate Frequency Transformer	RPT	Wiederholung	Repeat
			RT	Rotationsübertrager	Rotary Transformer
IND	Anzeige	Indicator	RUN	Bandlauf	Running
INH	Inhibit	Inhibit	RY	Relais	Relay
INS	Insertschnitt	Insert			
INT	intern	Internal	S		
INV	Inverter	Inverter	SAW	Sägezahnspannung	Sawtooth
I/O	Eingang/Ausgang	Input/Output	SC	Sub-Träger	Subcarrier
IR	Infrarot	Infrared	SCH	Suchlauf	Search
			SEL	Auswahl	Select
K			SENS	Sensor	Sensor
K	Kathode	Cathode	SENS CTL	Empfindlichkeitsregelung	Sensitivity Control
			SEP	Trennung	Separation
L			SF	Sourcefolger	Source Follower
L	Low-Pegel (0)	Low	SFF	kurzes Vorspulen	Short Fast Forward
LED		Light Emitting Diode	SFWD	Suchlauf vorwärts	Search Forward
LIN	Linearität	Linearity	SH	Farbschattierung	Shading
LIM	Begrenzer	Limiter	SIF	Ton-ZF	Sound Intermediate Frequency
LOAD	Einfädeln	Loading			
LP	Langspielgeschwindigkeit	Long Play	SN	Signal/Rausch-Abstand	Signal to Noise Ratio
LPF	Tiefpaßfilter	Low-pass Filter	SOL	Magnet	Solenoid
LSB	unteres Seitenband	Lower Sideband	SOS	Ton-Mischbetrieb	Sound on Sound
			SP	Normalspiegelgeschwindigkeit	Standard Play
M			SR	Abwickelspulenteller	Supply Reel
M	Motor	Motor	SREV	Suchlauf rückwärts	Search Reverse
MANU	manuell	Manual	SREW	kurzes Rückspulen	Short Rewind
MAX	maximum	Maximum	S/S	Zeitlupe/Standbild	Slow/Still
MDA	Motortreiberverstärker	Motor Drive Amplifier	SSG	Synchron-Impulsgenerator	Sync Signal Generator
MECHACON	Mechaniksteuerung	Mechanism Control	S. SH	statische Farbschattierung	Static Shading
MIC	Mikrofon	Microphone	SSNS	Startsensor	Start Sensor
MIN	Minimum	Minimum	STD	Normal	Standard
MIX	Mischstufe	Mixer	SUP	Abwickelspule	Supply
MMV	Monomultivibrator	Monostable Multivibrator	SW	Schalter	Switch
MOD	Modulator	Modulator	SWD	geschaltet	Switched
MODEM	Modulator-Demodulator	Modulator-Demodulator	SW REG	Schaltregler	Switching Regulator
MON	Monitor	Monitor	SYNC	Synchronisation	Synchronization
MOS	MOS	Metal Oxide Silicon	SYNC SEP	Synchronimpuls Trennstufe	Sync Separator
MPX	Multiplexer	Multiplexer	SYSCON	System-Überwachung	System Control
MS	Betriebsartwahl	Mode Select			
MUT	Tonabschaltung	Muting	V		
			V	vertikal	Vertical
N			VCO	spannungsgesteuerter Oszillator	Voltage Controlled Oscillator
NAND	Not-And	Not-And	VD	vert. Treiberimpuls	Vertical Drive Pulse
NC	nicht belegt	Not Connected	VP	vert. Parabelimpuls	Vertical Parabolic Pulse
ND	Dämpfungsfiler	Neutral Density (Filter)	VR	Poti	Variable Resistor
NFB	Gegenkopplung	Negative Feedback	VS	vert. Sägezahnimpuls	Vertical Sawtoothed Pulse
NLN	nicht linear	Non-Linear	VXO	steuerbarer Quarzoszillator	Variable Crystal Oscillator
NO	normalerweise offen	Normally Open	VLT	violett	Violet
NOR	normal	Normal	V/T	Video/Fernsehen	Video/Television
			V/U	VHF/UHF	VHF/UHF
O			VSCH	variable Suchlaufgeschw.	Variable Search
OB	optischer Schwarzwert	Optical Black			
OPAMP	Operationsverstärker	Operational Amplifier	W		
OP	optisch	Optical	WARN	Warnanzeige	Warning
ORN	orange	Orange	W. BAL	Weißabgleich	White Balance
OSC	Oszillator	Oscillator	WHT	weiß	White
			WV	Arbeits-Spannung	Working Voltage
P			W & D	weiß und schwarz	White and Dark
PAR	Parabel	Parabola			
PB	Wiedergabe	Playback	X		
PC	Photokoppler	Photocoupler	XTAL	Quarz	Crystal
PCM	Puls-Code-Modulation	Pulse Code Modulation			
PED	Schwarzwert	Pedestal	Y		
PGM	Programm	Program	Y	Luminanzsignal	Luminance
PG	Impulsgenerator	Pulse Generator	YEL	gelb	Yellow
PI	Lichtschanke	Photo Interrupter	YL	Y-Signal, schmalbandig	Luminance Low Band Signal
PLL	Phasenregelkreis	Phase Locked Loop	YW	Y-Signal, breitbandig	Luminance Wide Band Signal
p-p	Spitze-Spitze	Peak-to-Peak			
POS	Position	Position			
PR	Andruckrolle	Pinch Roller			
PREAMP	Vorverstärker	Preamplifier			
PRL	Umschwenken (Zwischenrad)	Preroll			
P/S	Pause/Standbild	Pause/Still			
PSC	Impuls-Anstiegssteuerung	Pulse Swallowing Control			
PU	Aufnehmer	Pickup			
PWB	Schaltungsplatte	Printed Wiring Board			
PWM	Pulsbreitenmodulation	Pulse Width Modulation			
PWR	Stromversorgung	Power			
Q					
Q	Güte	Quality Factor			
R					
R	rot	Red			
RA	Widerstands-Array	Resistor Array			
RAM	RAM	Random Access Memory			
REC	Aufnahme	Recording			
REF	Bezug, Referenz	Reference			
REG	Regler	Regulator			
REMOCON	Fernsteuerung	Remote Control			
REV	Vertauschung	Reverse			
REW	Rückspulen	Rewind			
RF	HF	Radio Frequency			

Verdrahtungsplan · Wiring Diagram

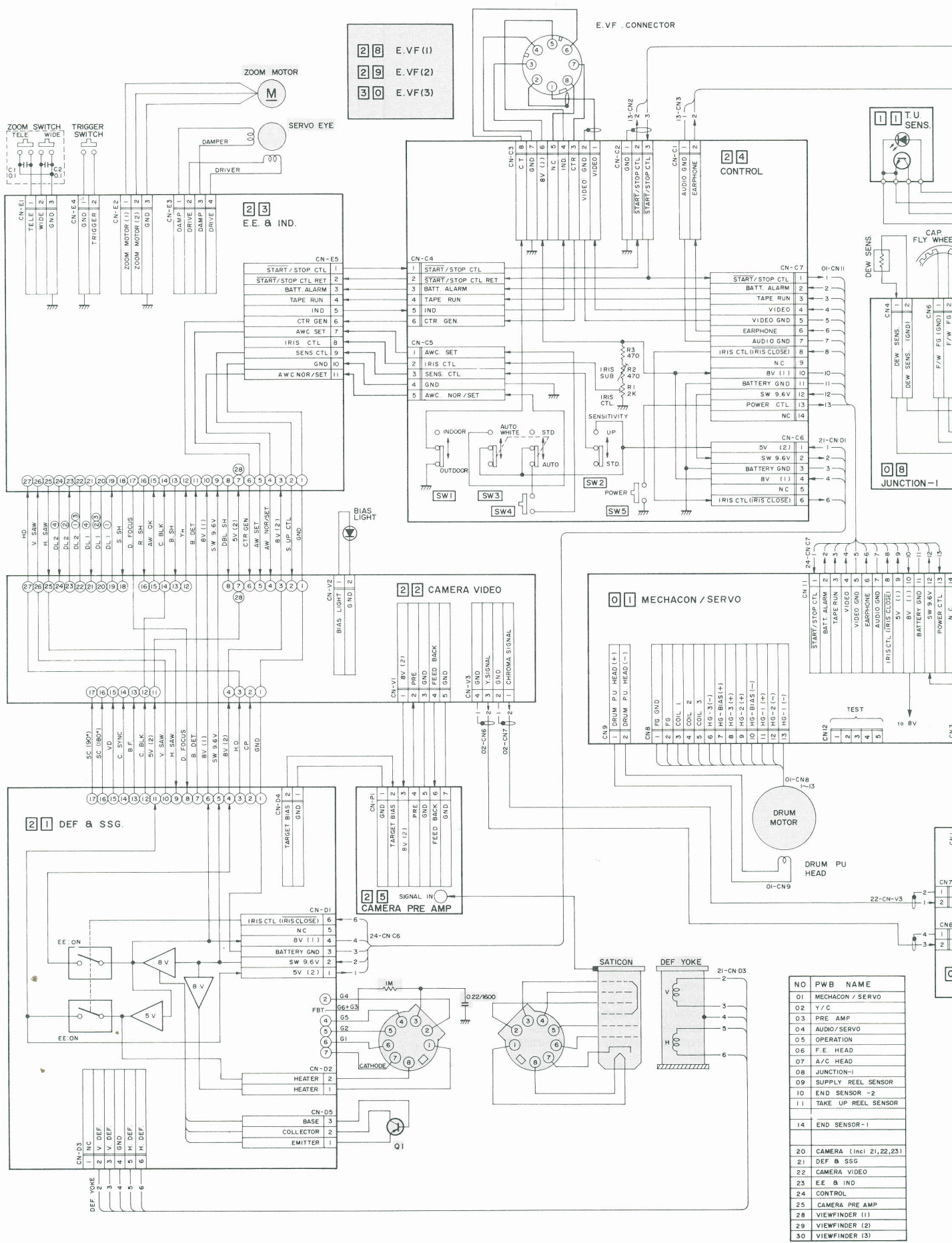

NO	PWB NAME
01	MECHA CON / SERVO
02	Y / C
03	PRE AMP
04	AUDIO / SERVO
05	OPERATION
06	F.E. HEAD
07	A/C HEAD
08	JUNCTION-1
09	SUPPLY REEL SENSOR
10	END SENSOR -2
11	TAKE UP REEL SENSOR
14	END SENSOR -1
20	CAMERA (Incl 21,22,23)
21	DEF & SSG
22	CAMERA VIDEO
23	E.E. & IND
24	CONTROL
25	CAMERA PRE AMP
28	VIEWFINDER (1)
29	VIEWFINDER (2)
30	VIEWFINDER (3)

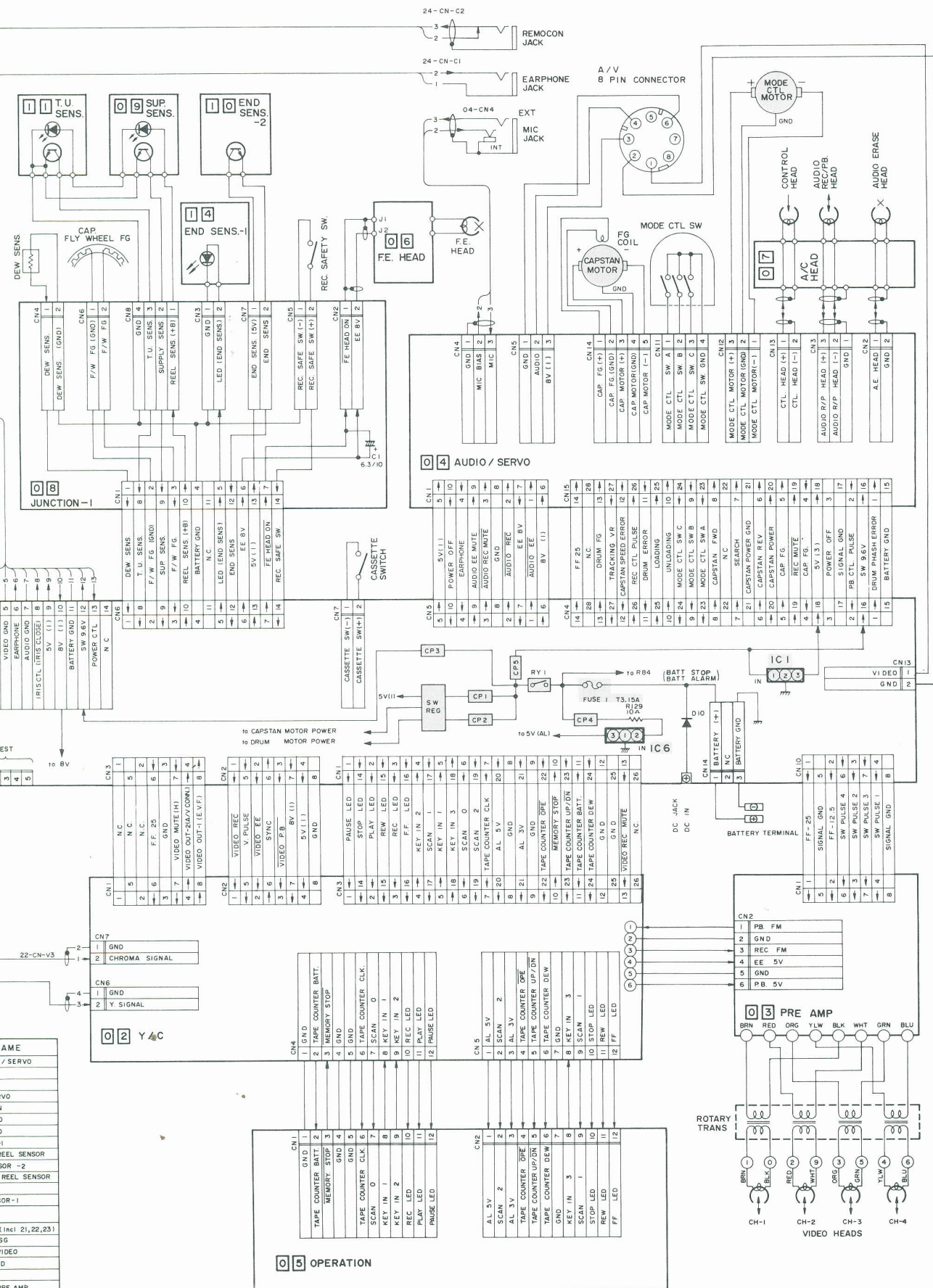

NOTE:
 [Shaded Box] parts are importantly related to safety.
 When replacing them, make sure to use specified parts.

Audio-Blockschaltbild Audio block diagram

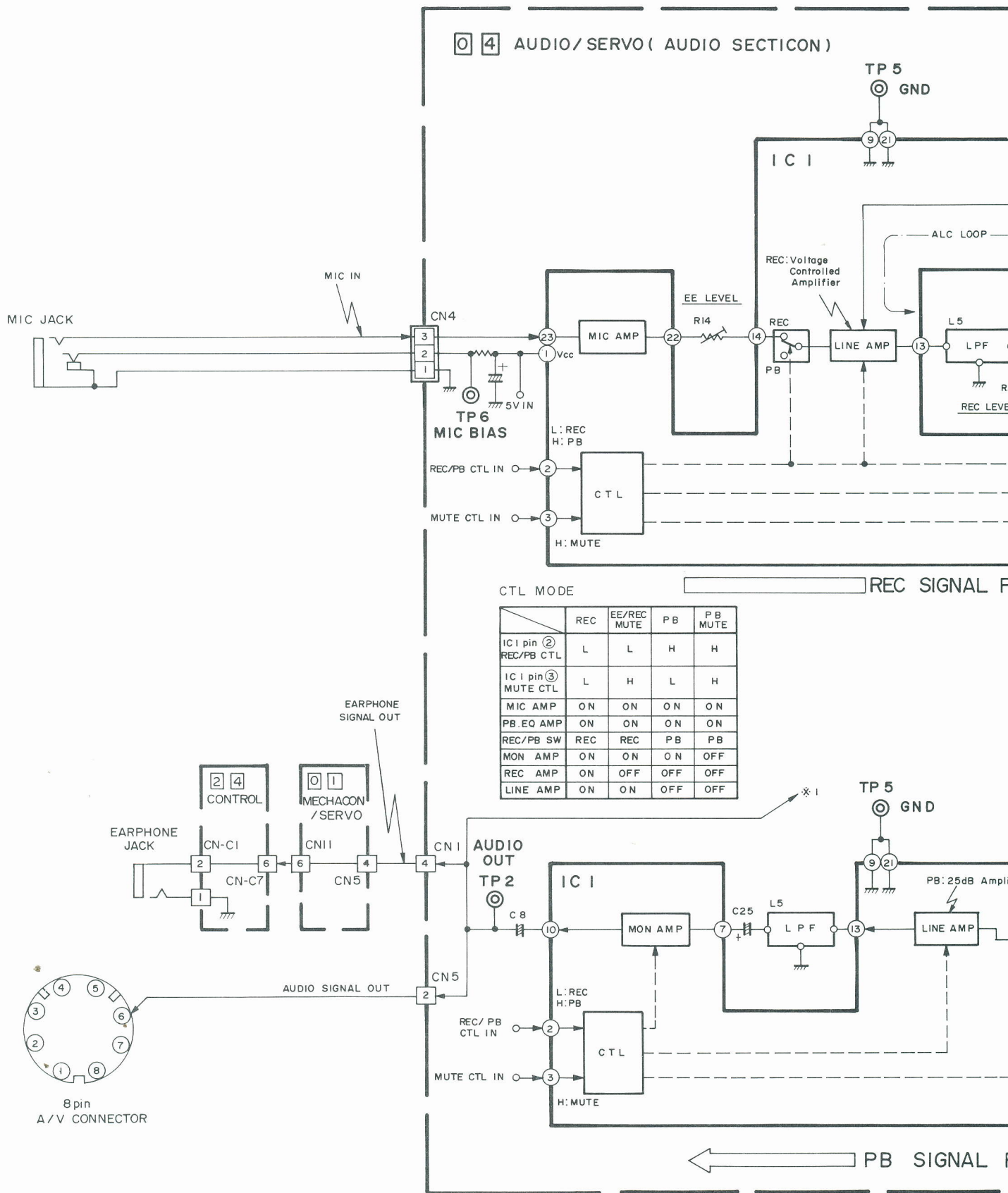

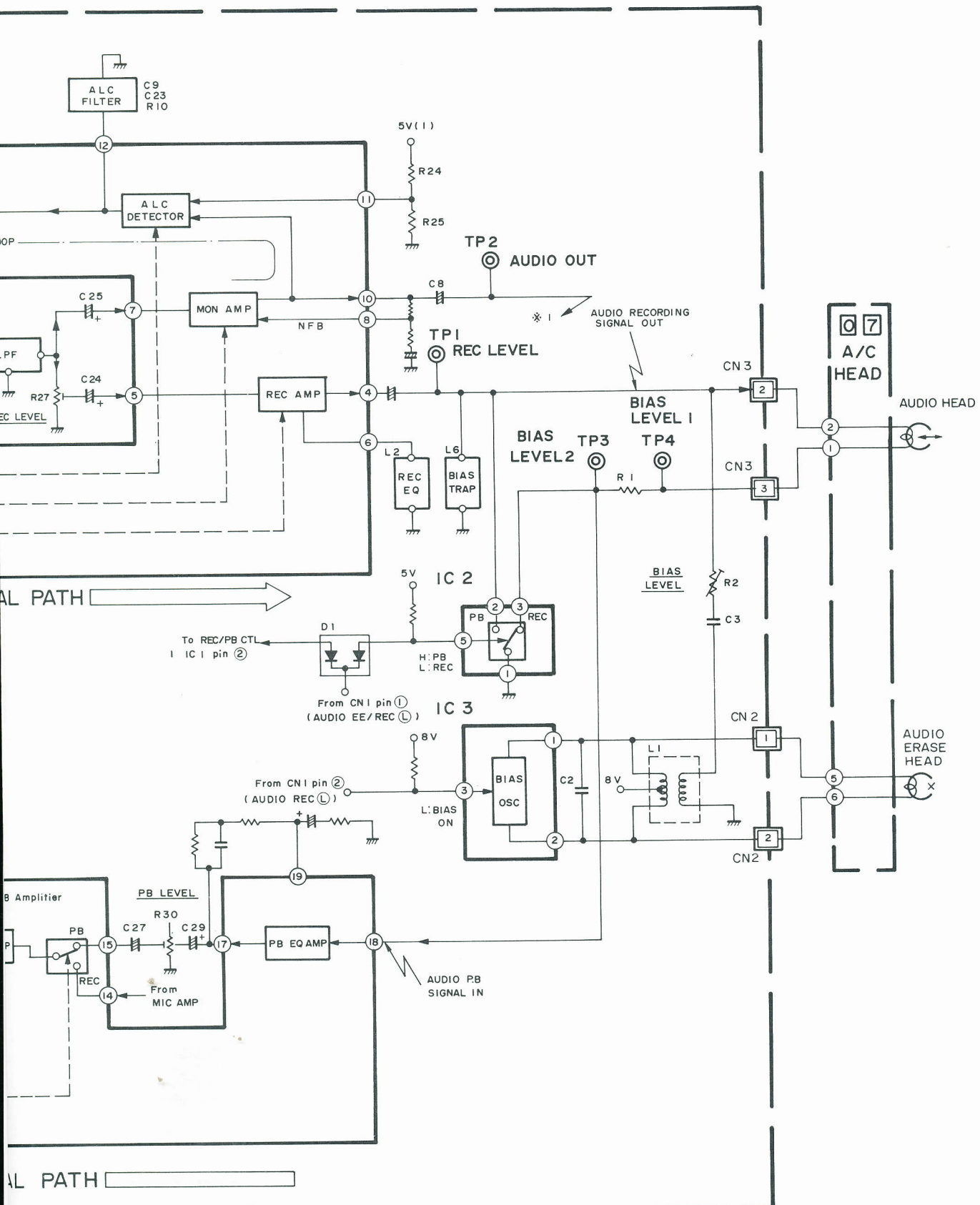

Video-Blockschaltbild (Farbsignal) Video block diagram (chroma signal)

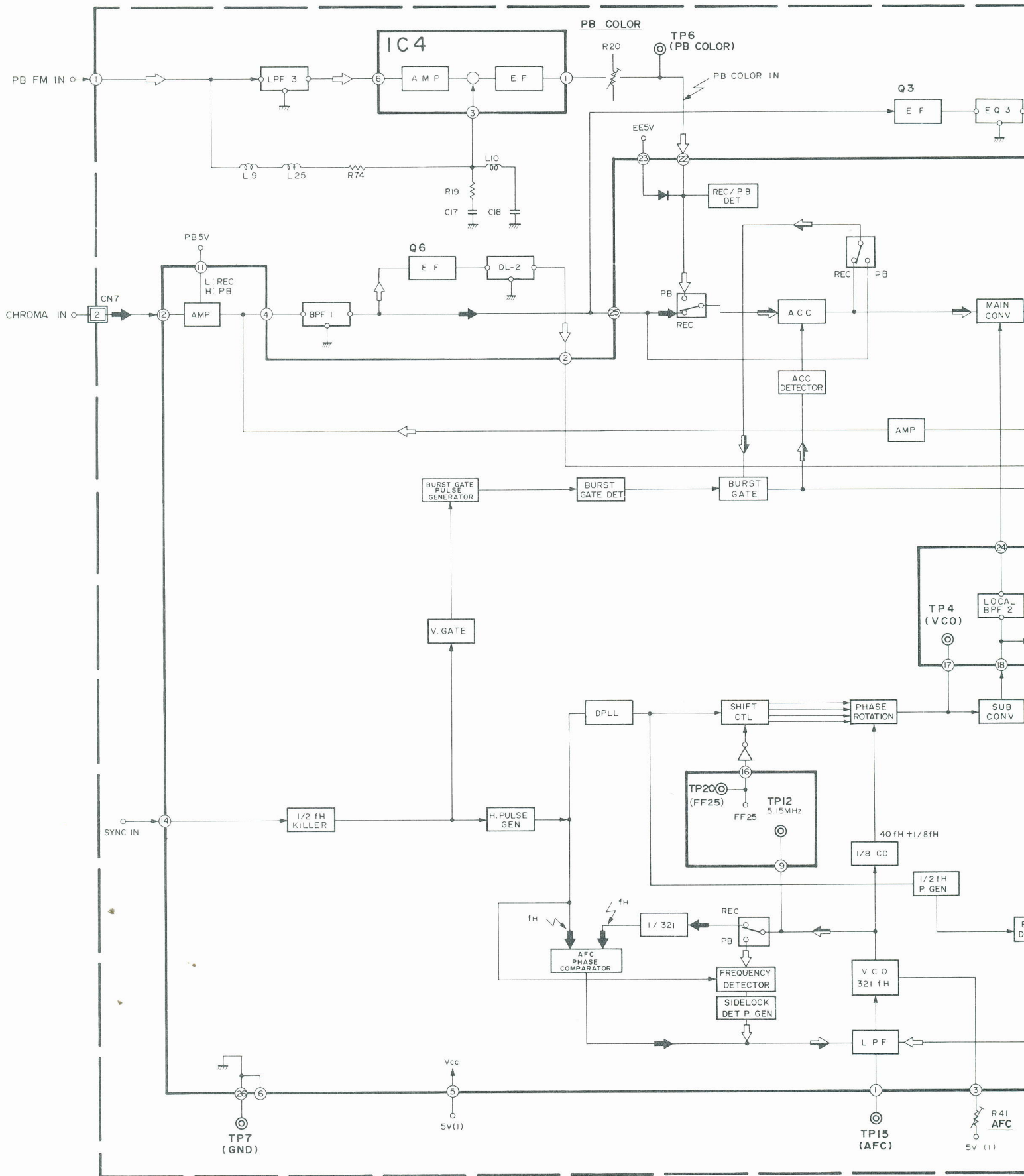

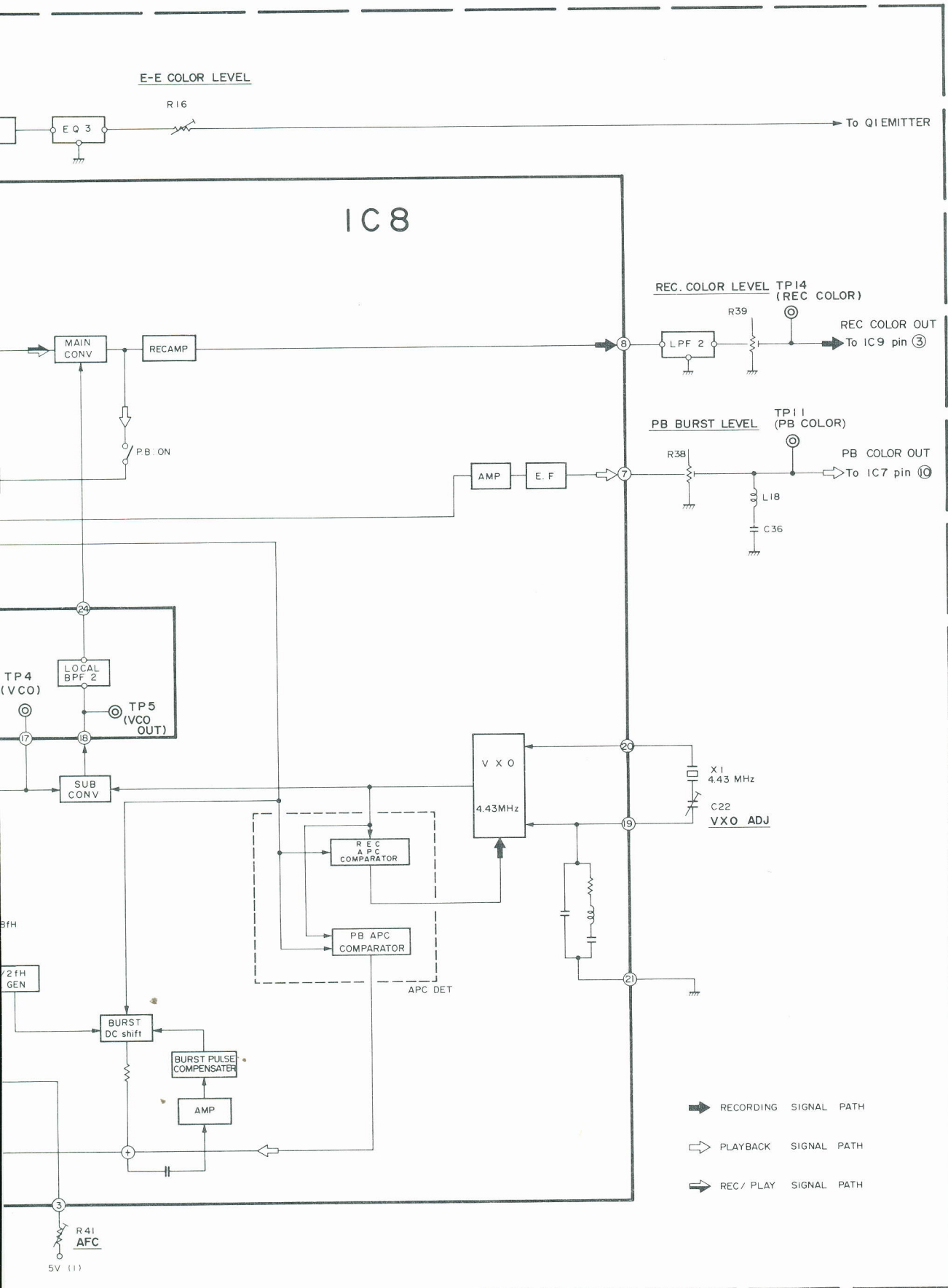

Video-Blockschaltbild (Luminanzsignal) Video block diagram (luminance signal)

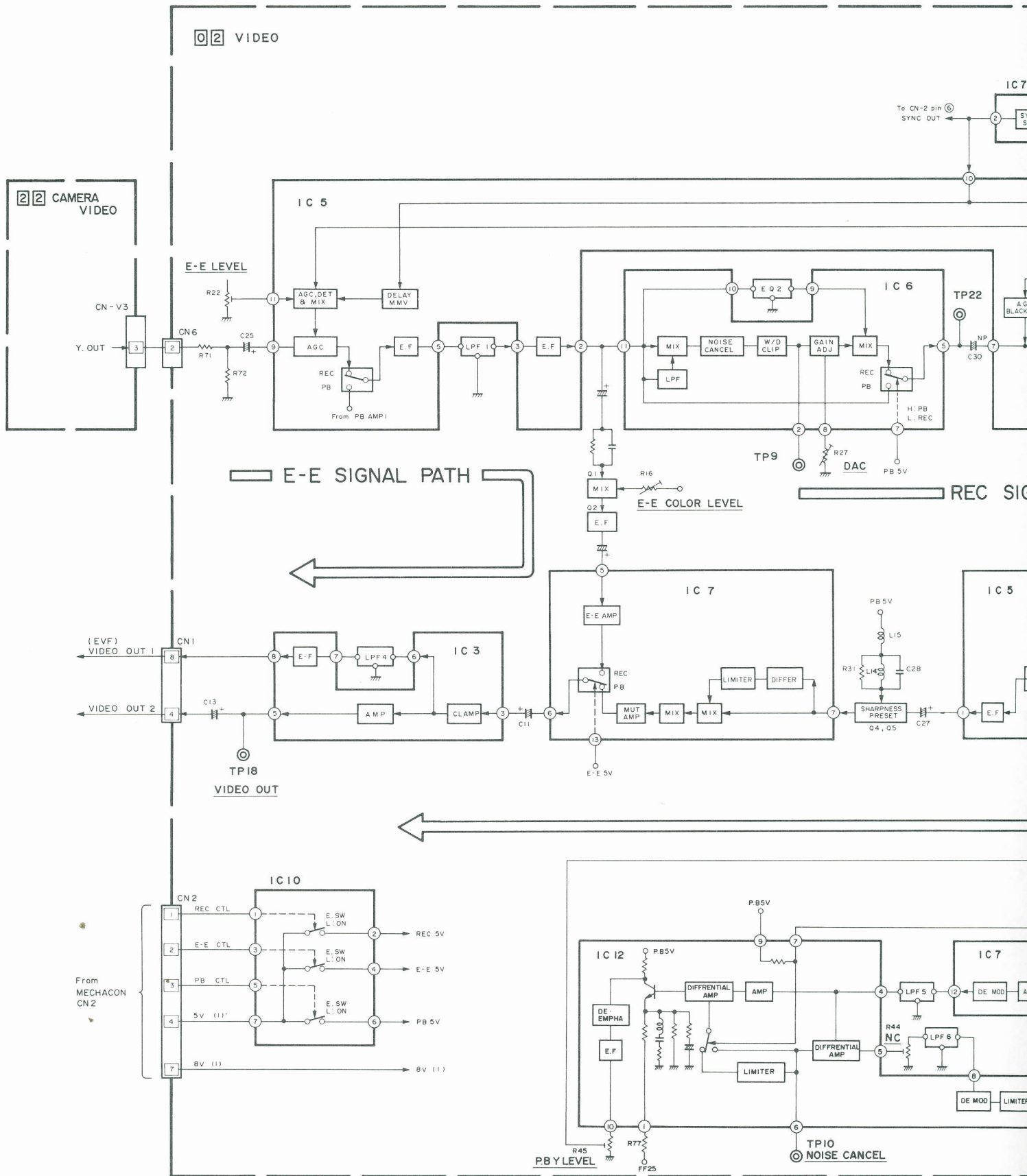

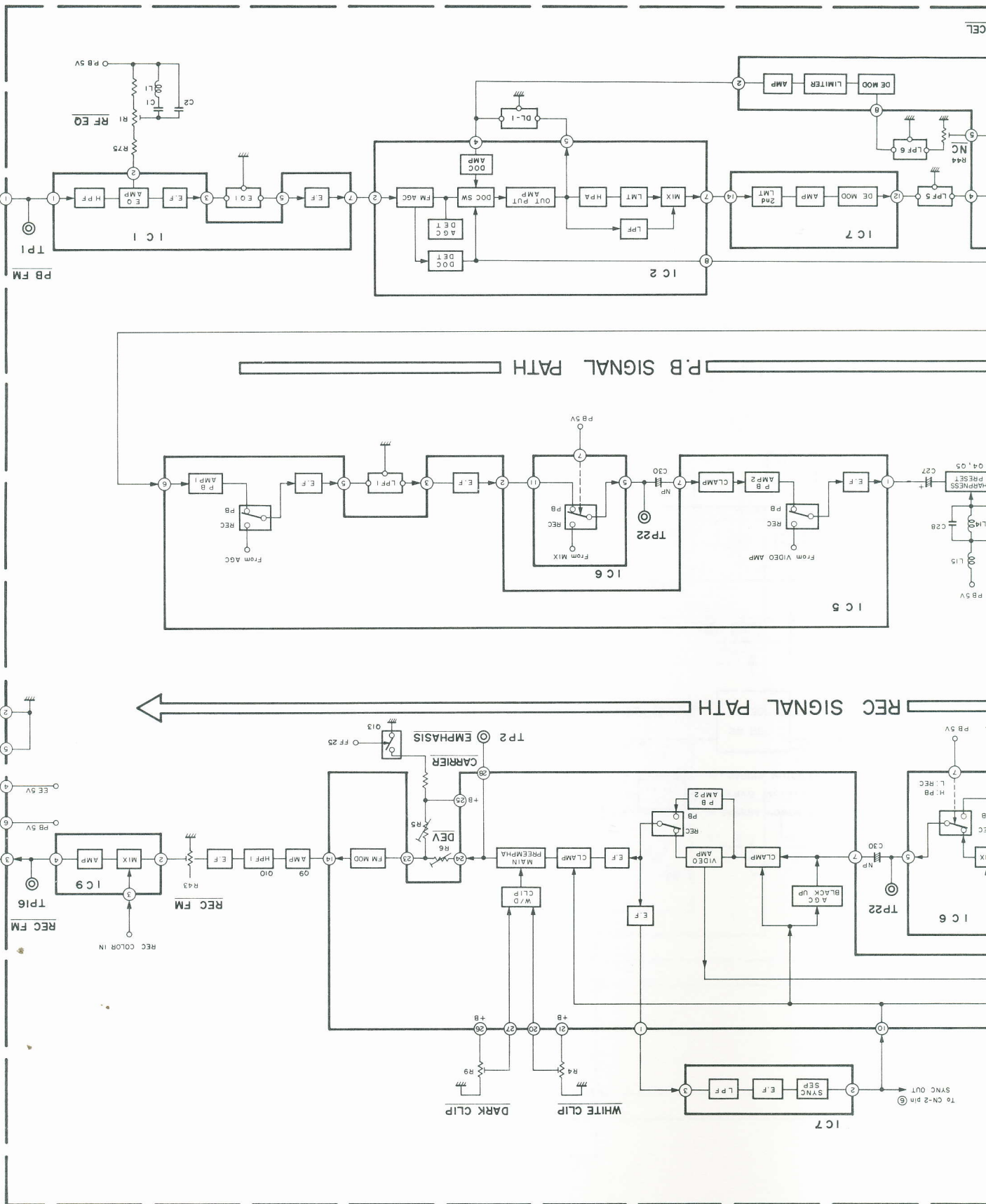

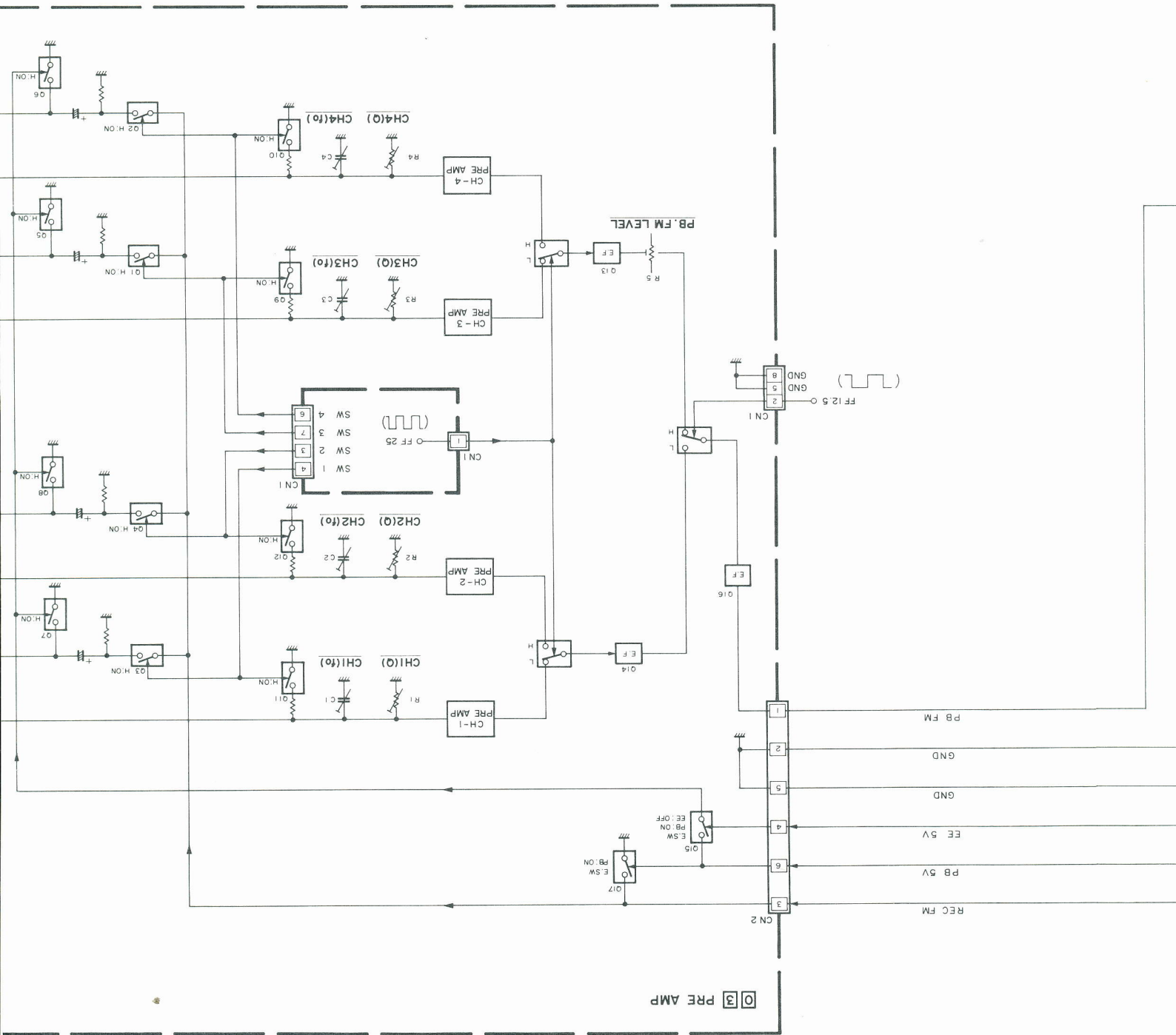

P-B MODE

SWITCHING PULSE TIMING CHART

PRE AMP IC CN1
 (A) = SUP OVER LAP
 (B) = TU OVER LAP

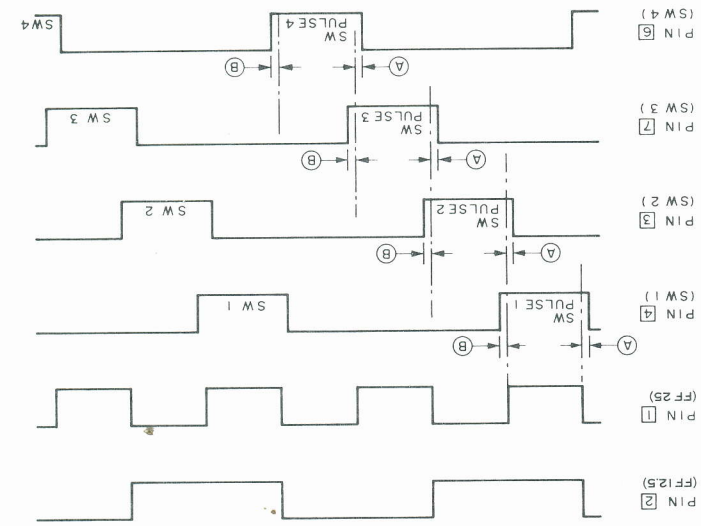

REC MODE

SWITCHING PULSE TIMING CHART

(A) = SUP OVER LAP
 (B) = TU OVER LAP

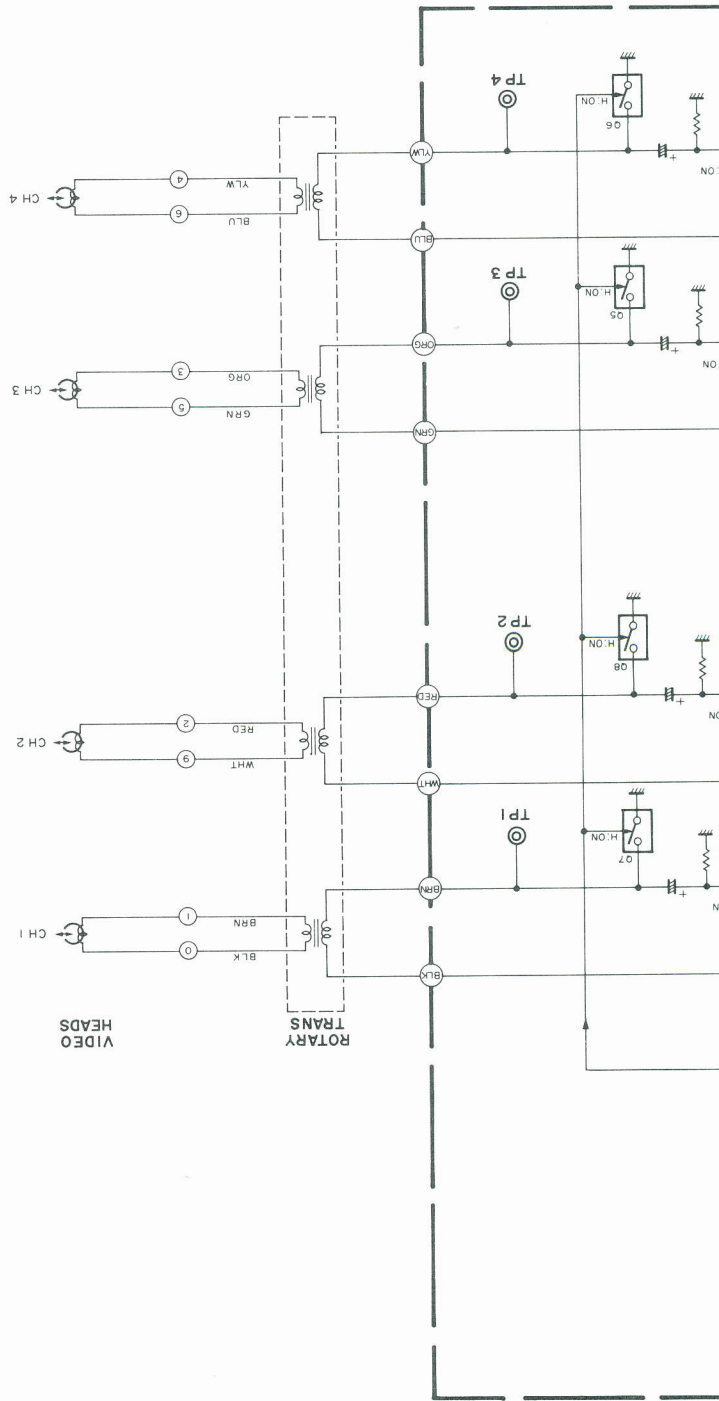
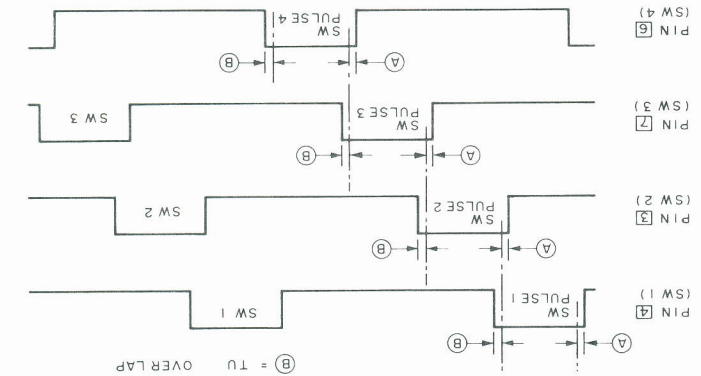

Mechaniksteuerung Blockschaltbild

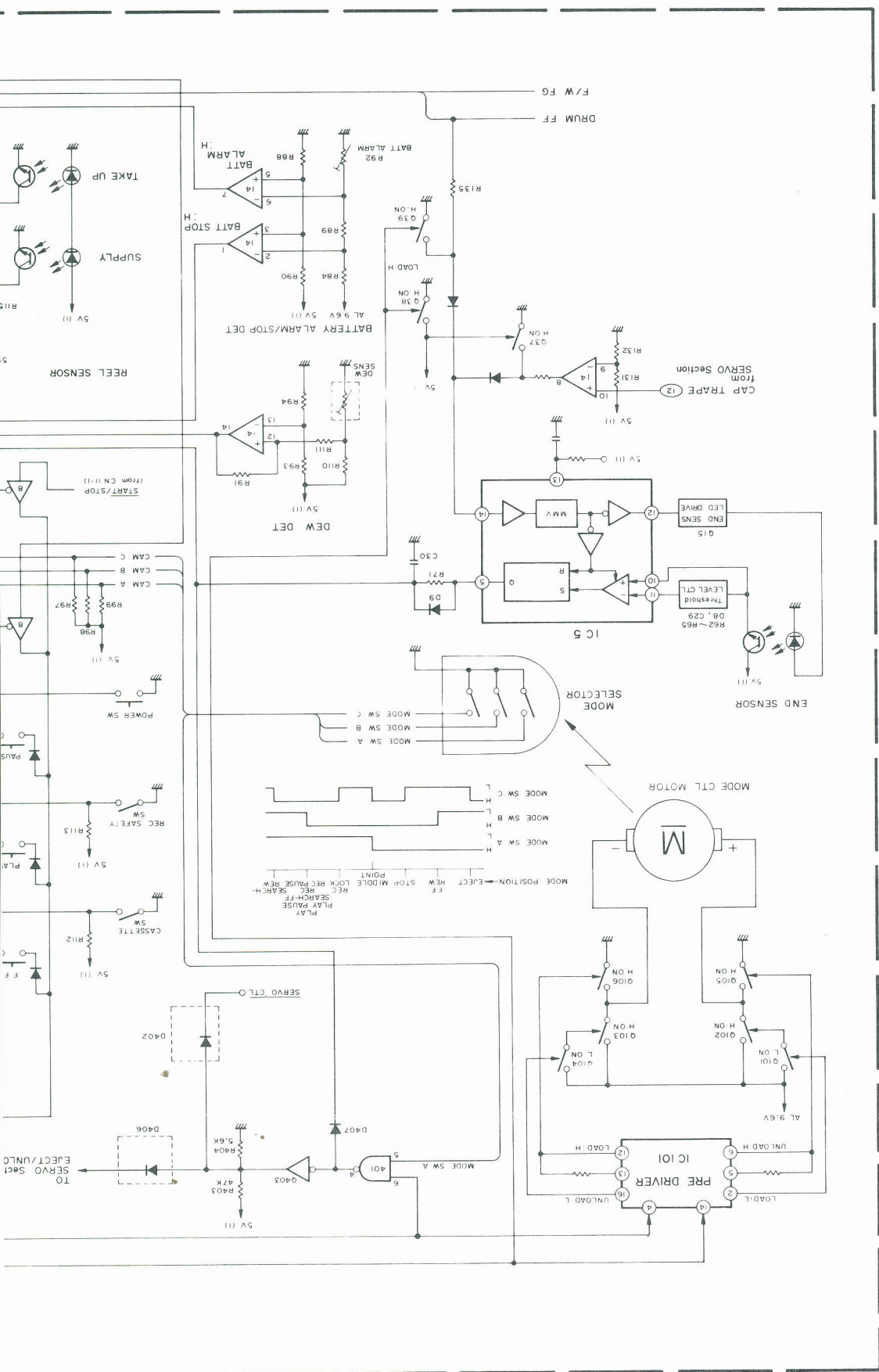

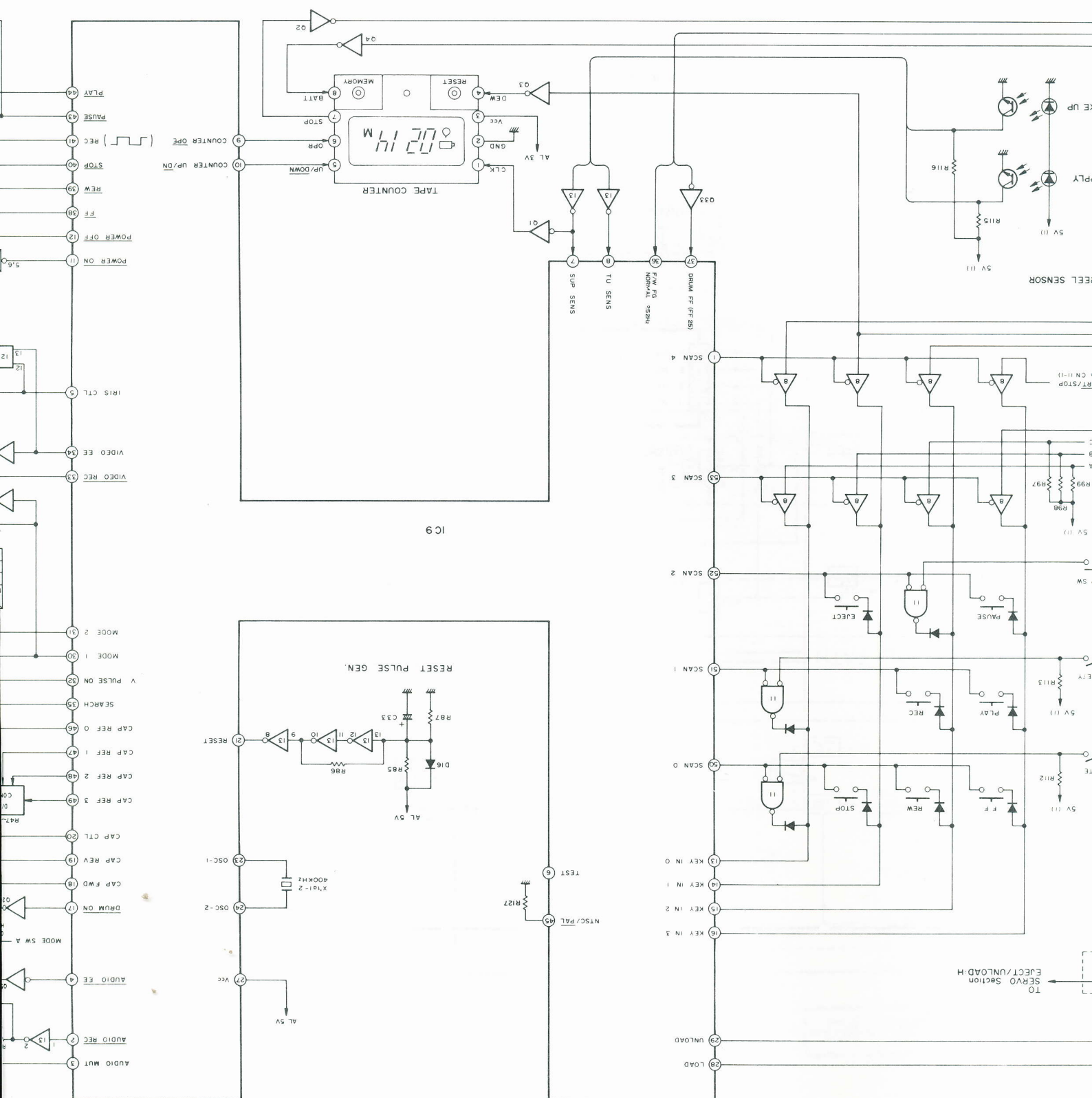

IC9

RESET PULSE GEN.

FEEL SENSOR

RT/STOP

5V (1)

5V (1)

5V (1)

5V (1)

5V (1)

TO SERVO SECTION H
EJECT/UNLOAD H

Offen -
Dauerbetrieb

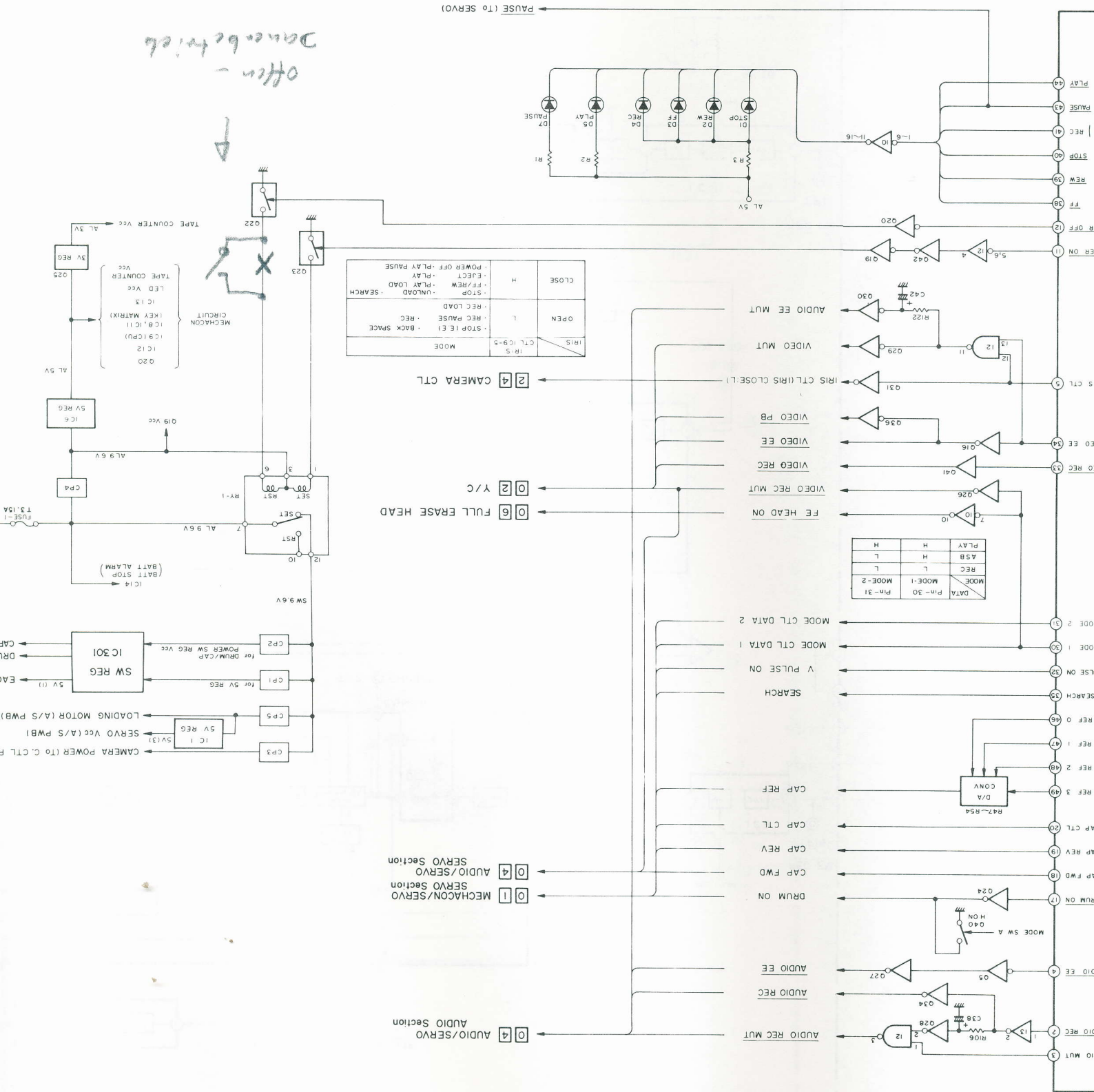

Mechaniksteuerung Blockschaltbild Mechacon block diagram

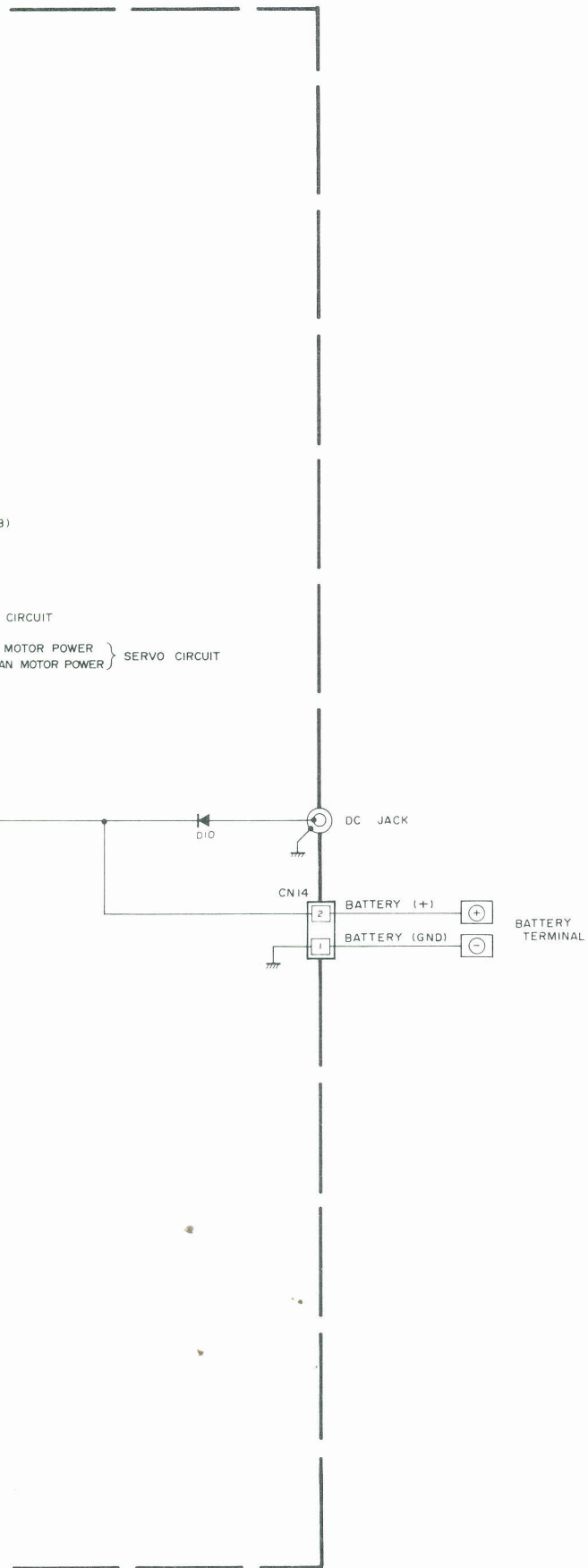

Mechaniksteuerung Impulsdiagramm Mechacon timing chart

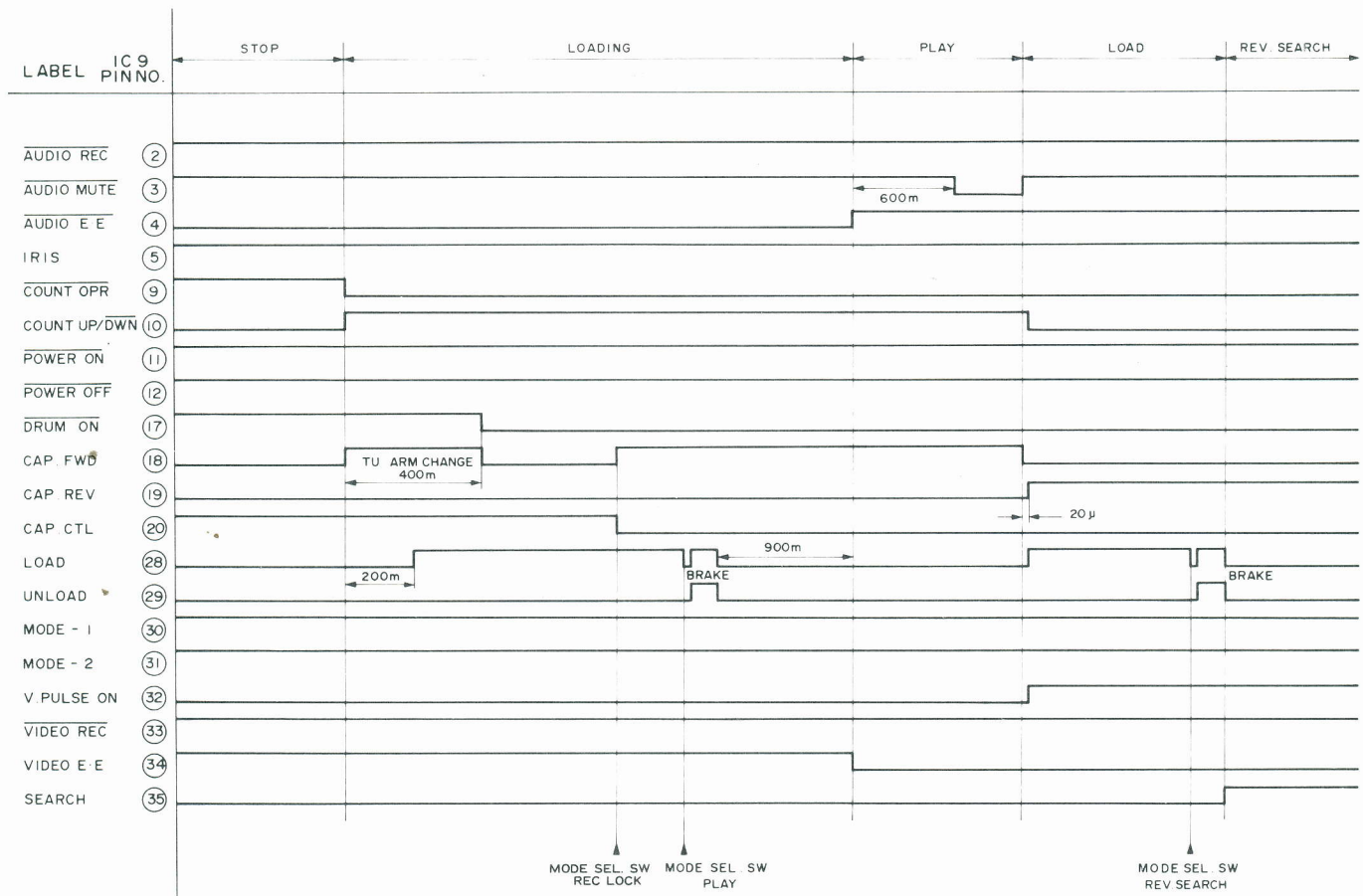
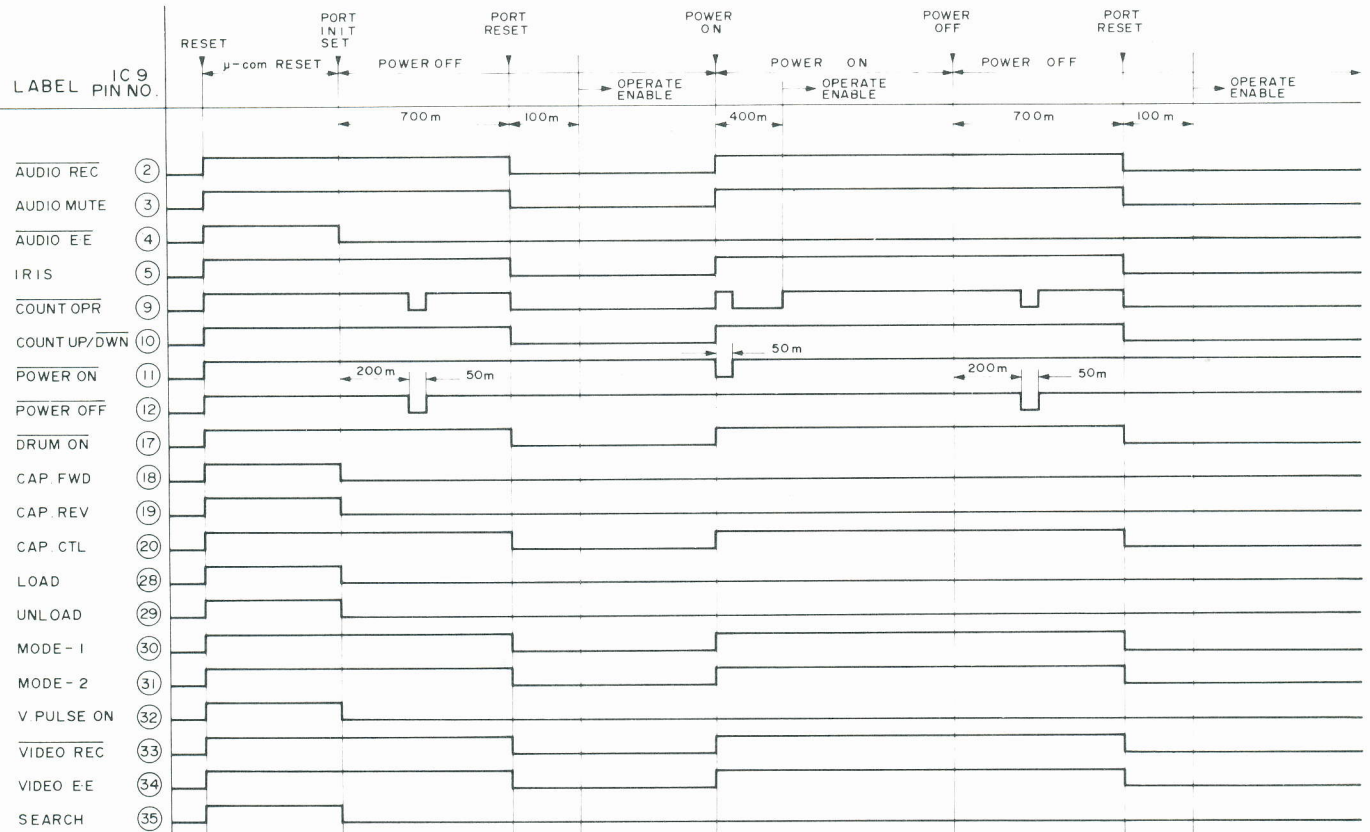

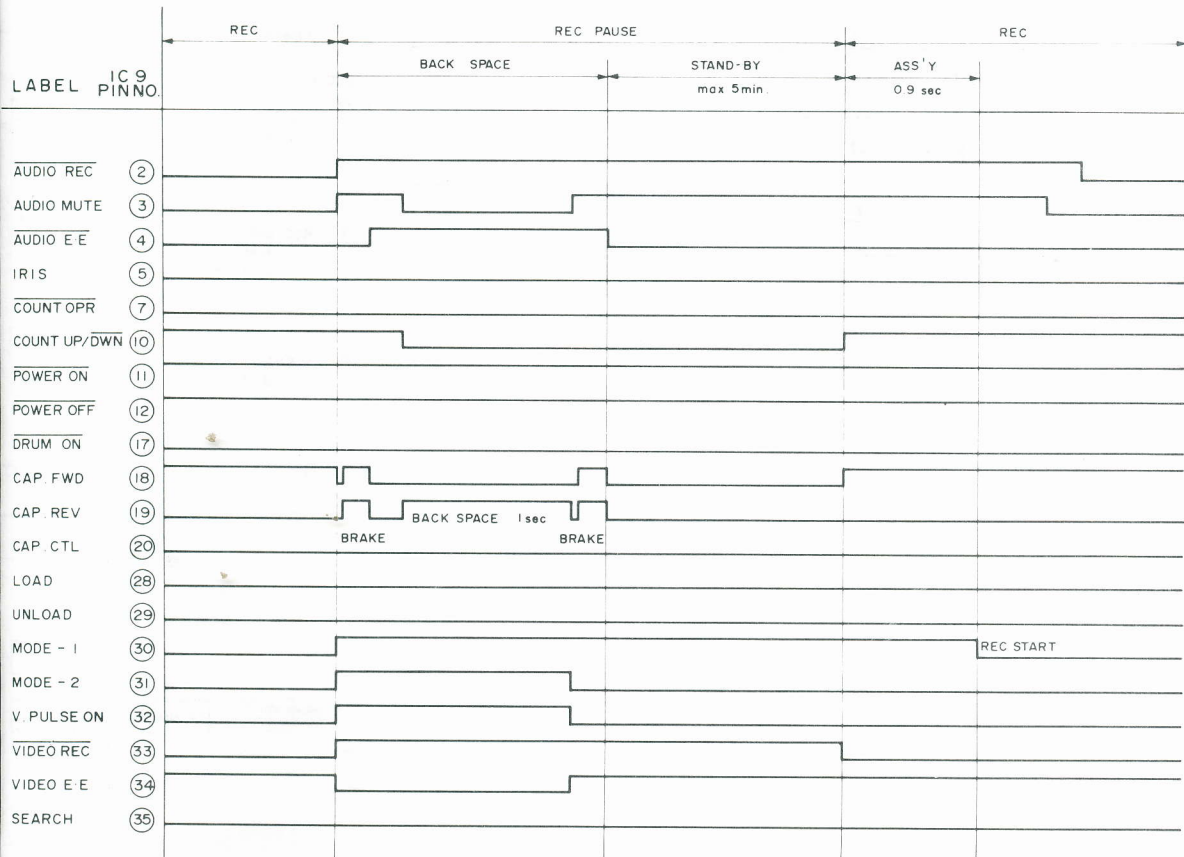
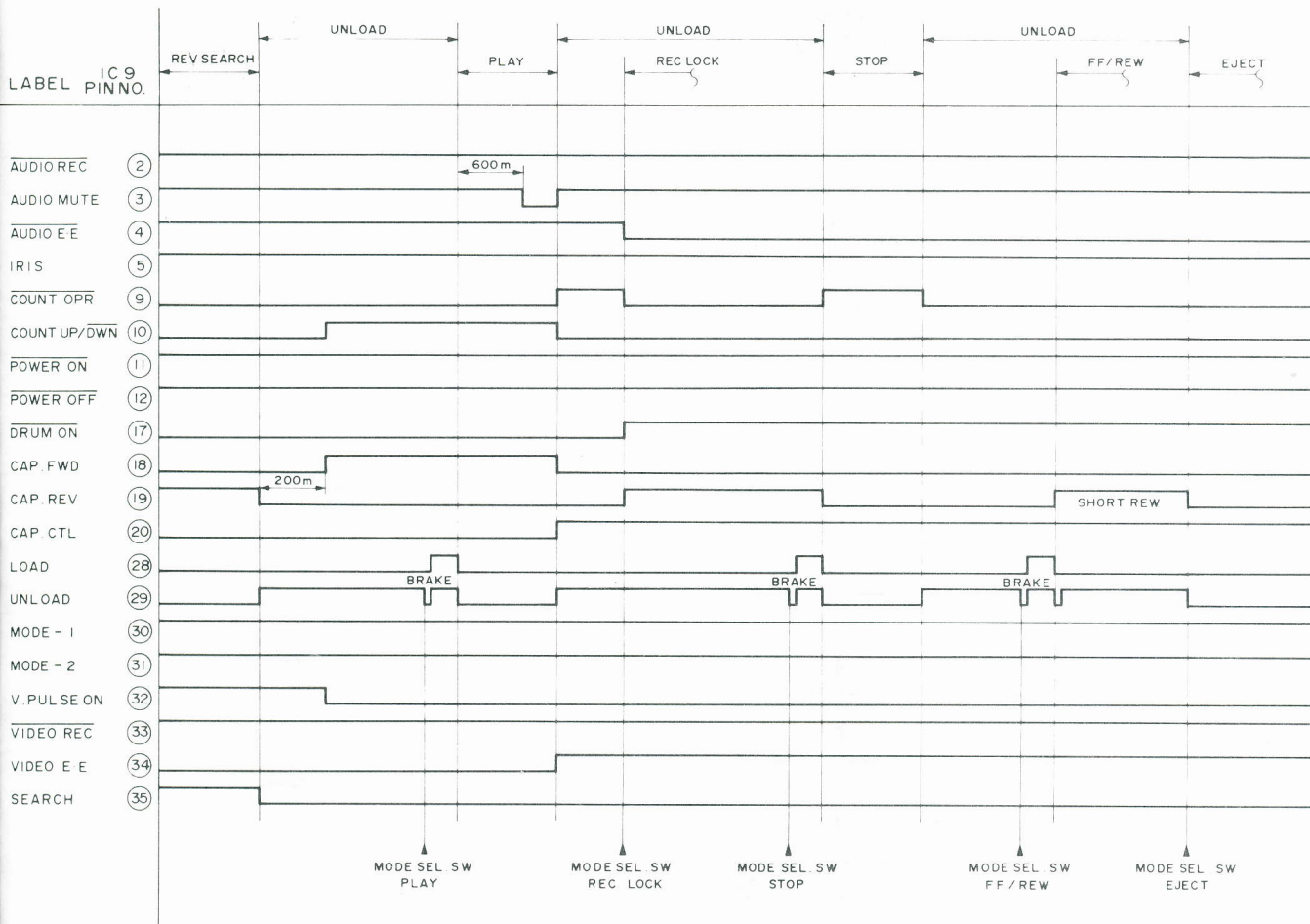

SYNC
 Y/C

Kopftrommelservo Impulsdiagramm

Drum servo timing chart

Schaltlogik
Switch logic

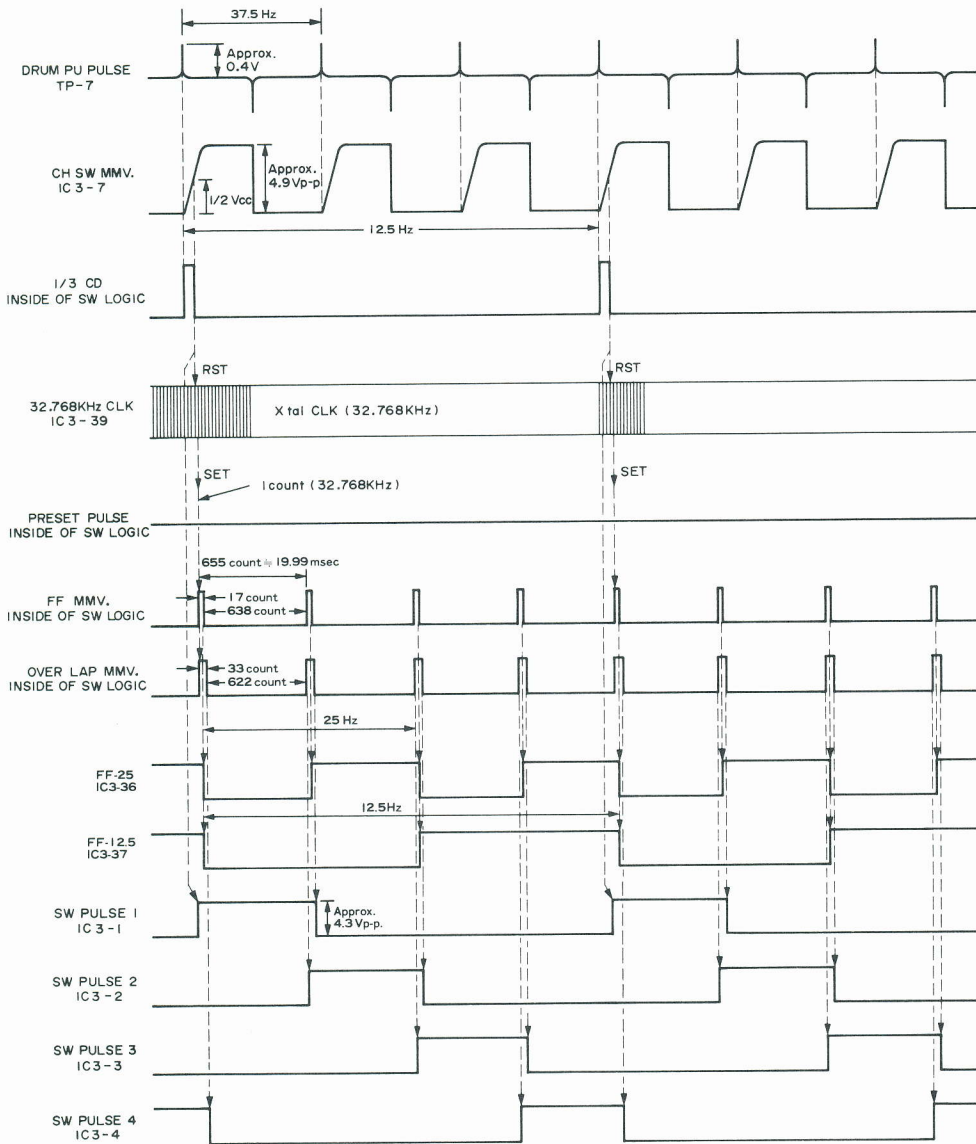

Aufnahm
REC mod

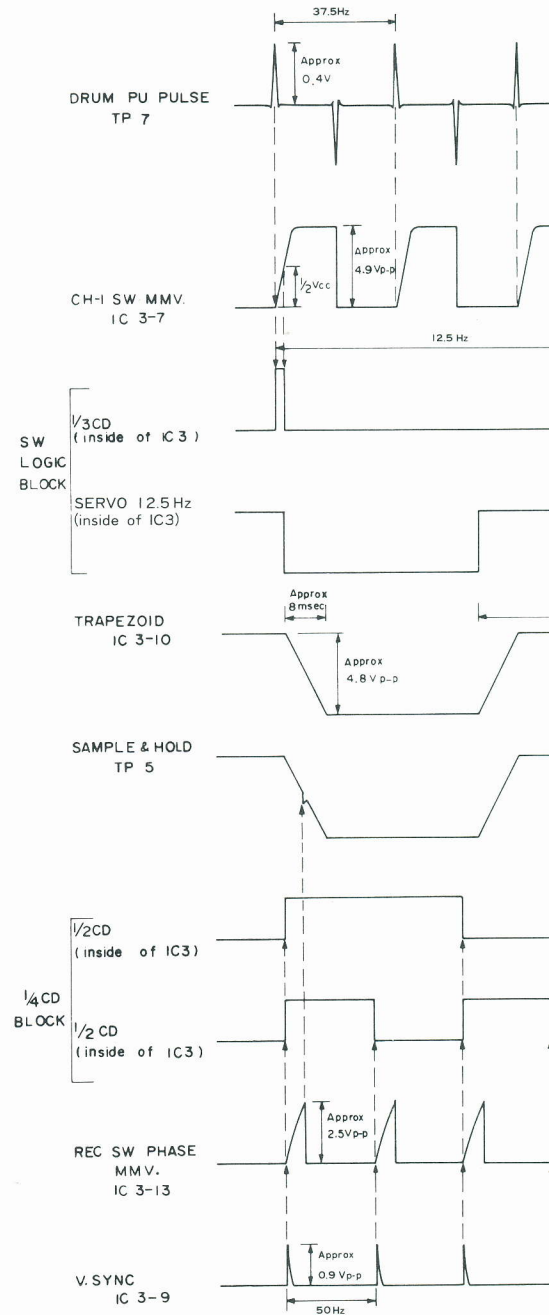

IC3 SWITCHING LOGIC

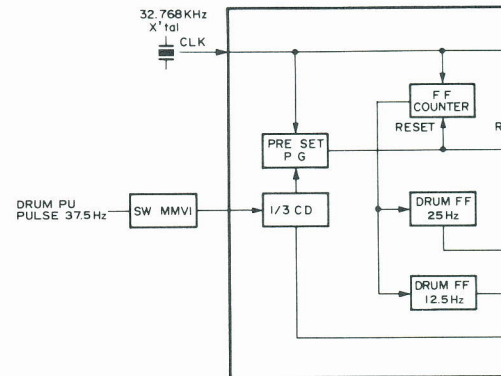

Aufnahme
REC mode

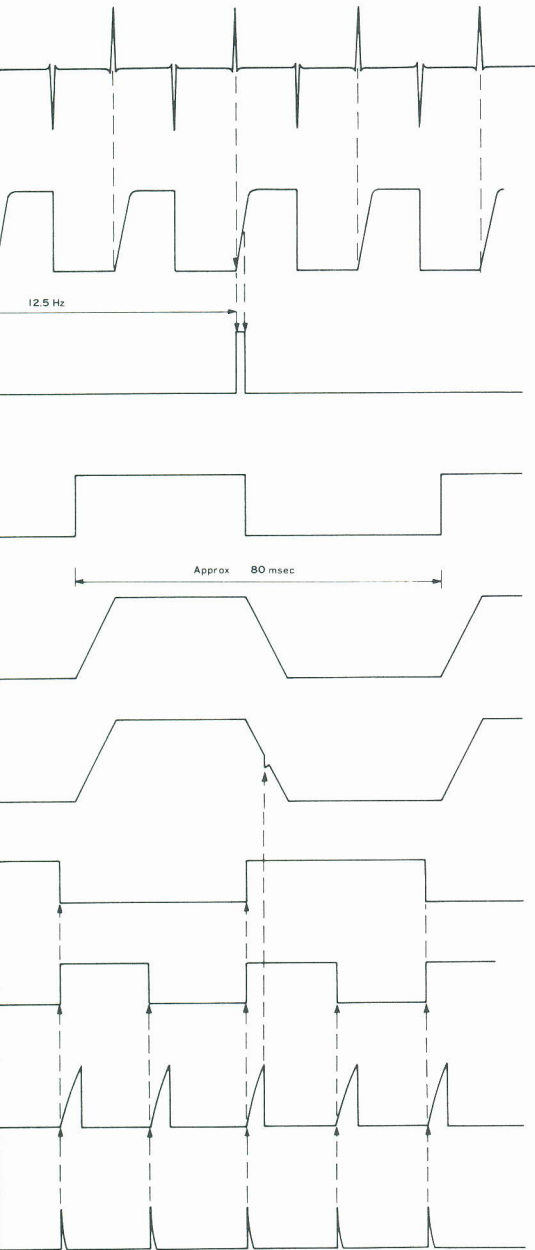

Wiedergabe
PB Mode

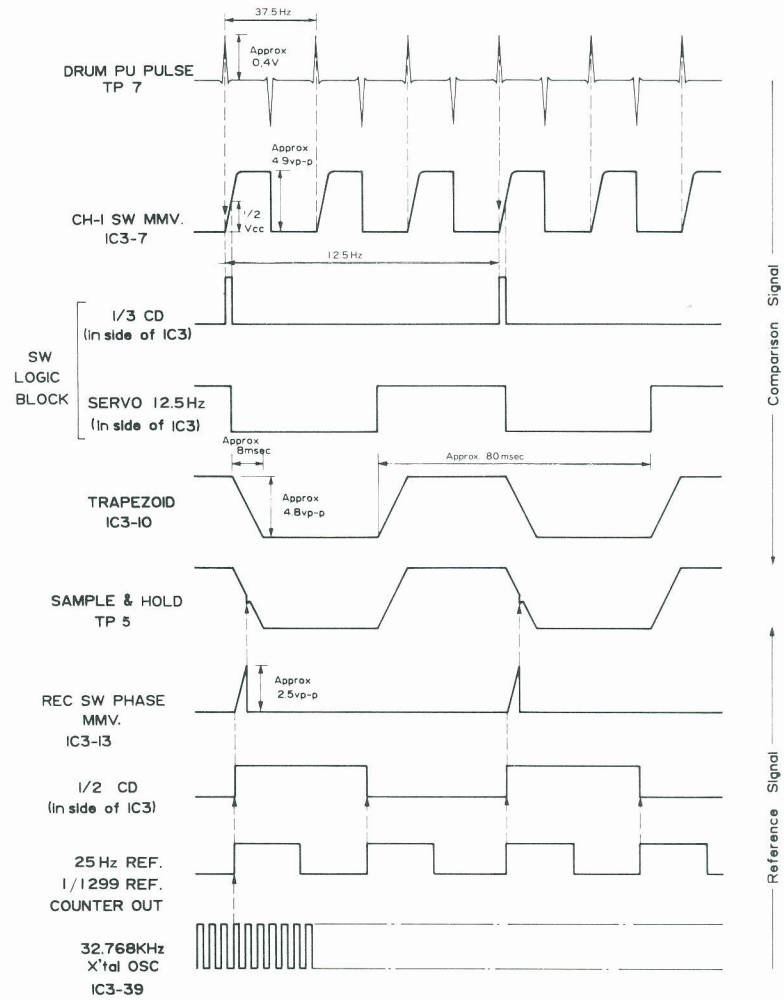

DRUM LOGIC BLOCK DIAGRAM

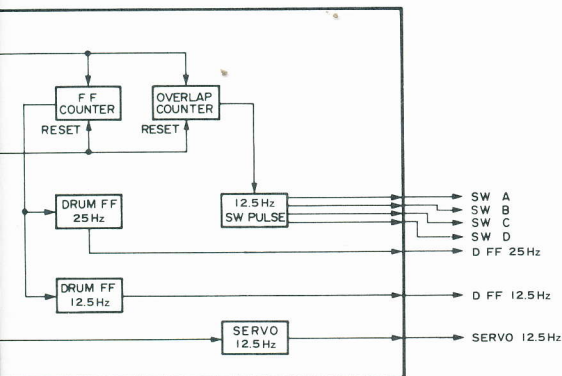

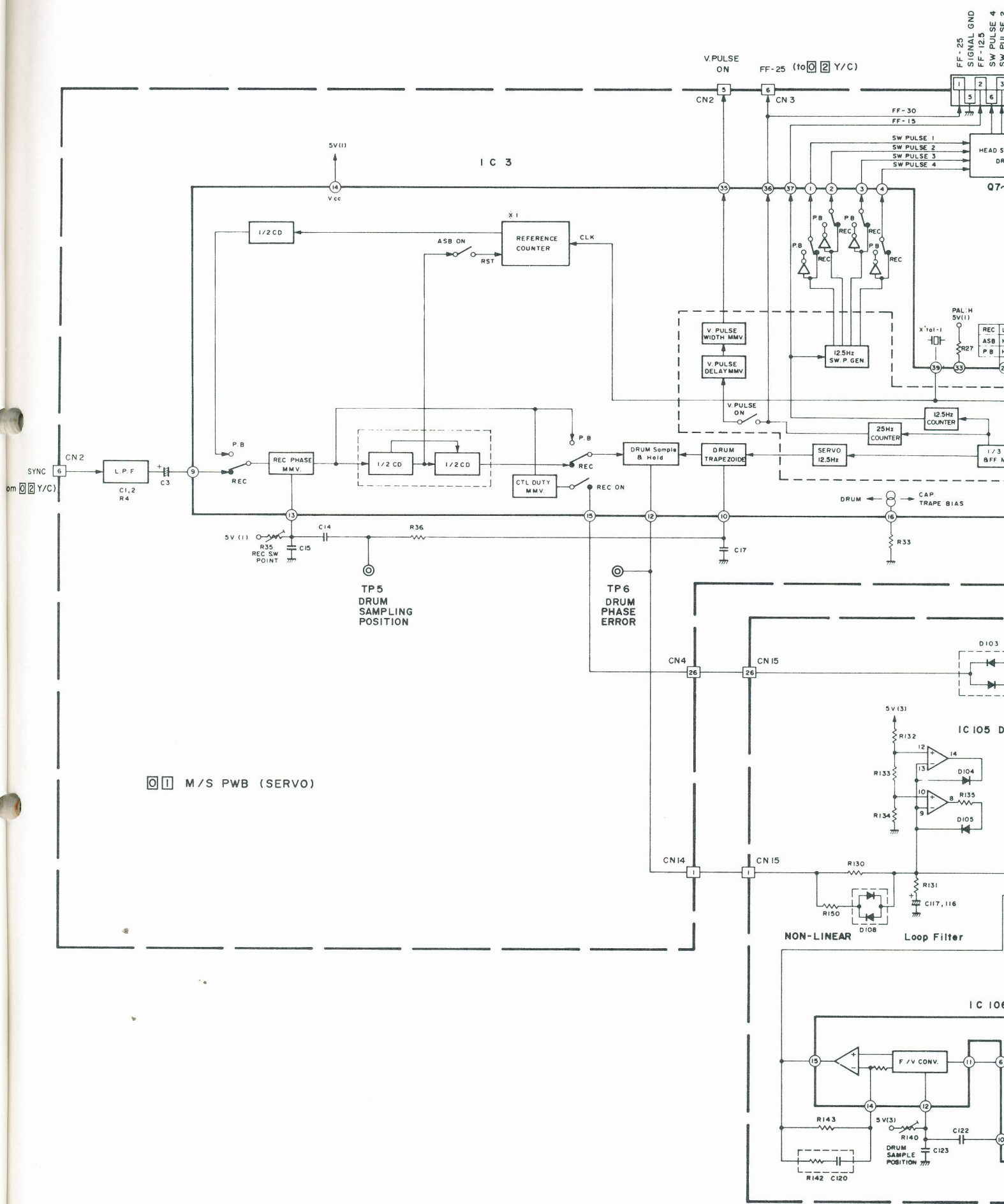

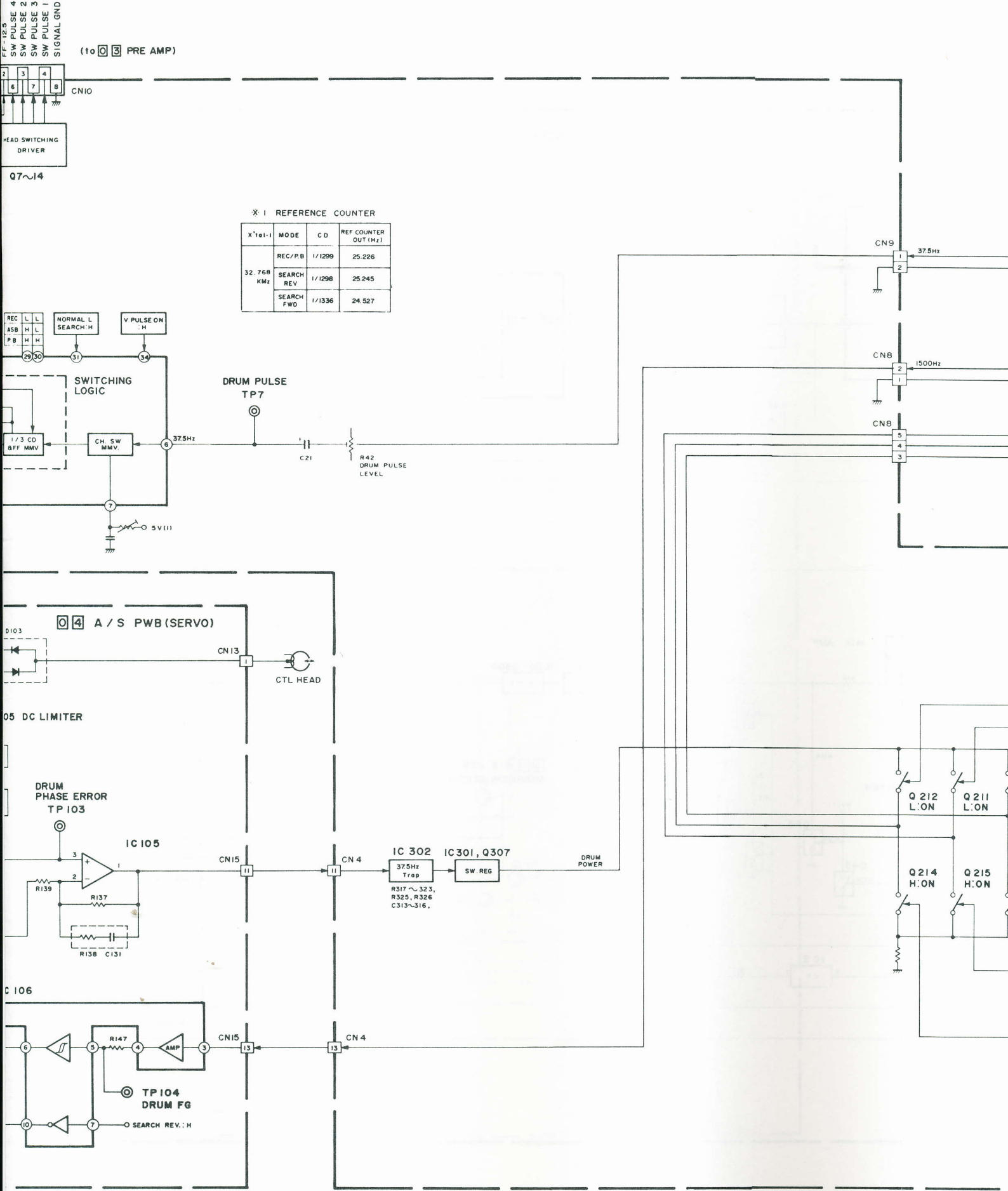

Kopffrommelservo Blockschaltbild Drum servo block diagram

DRUM MDA TIMING CHART

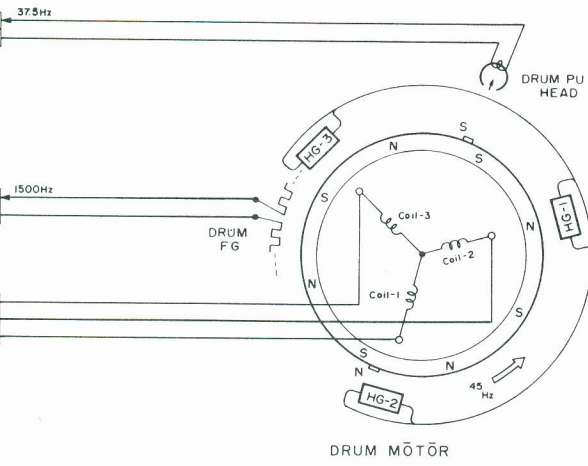
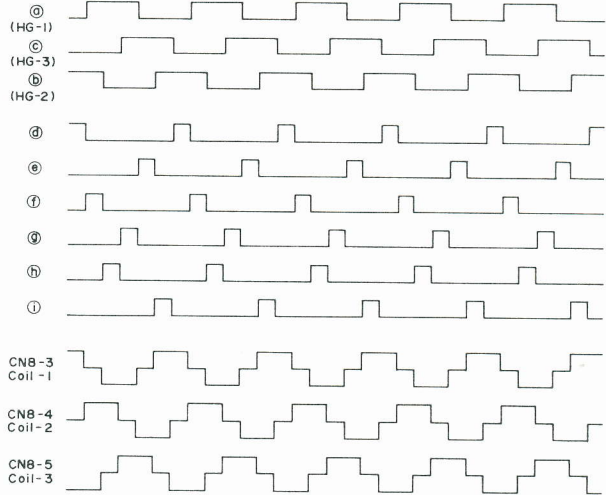

DRUM MDA

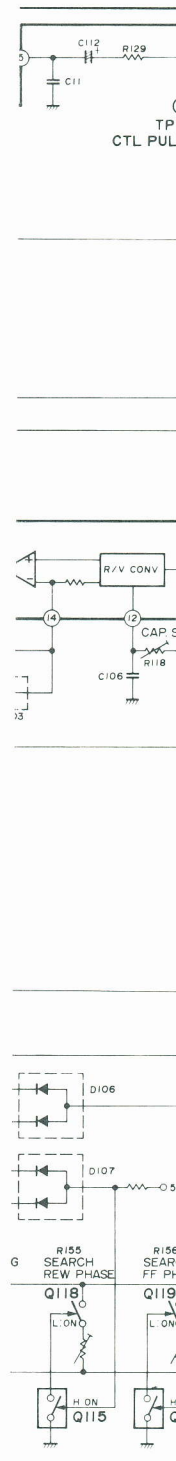
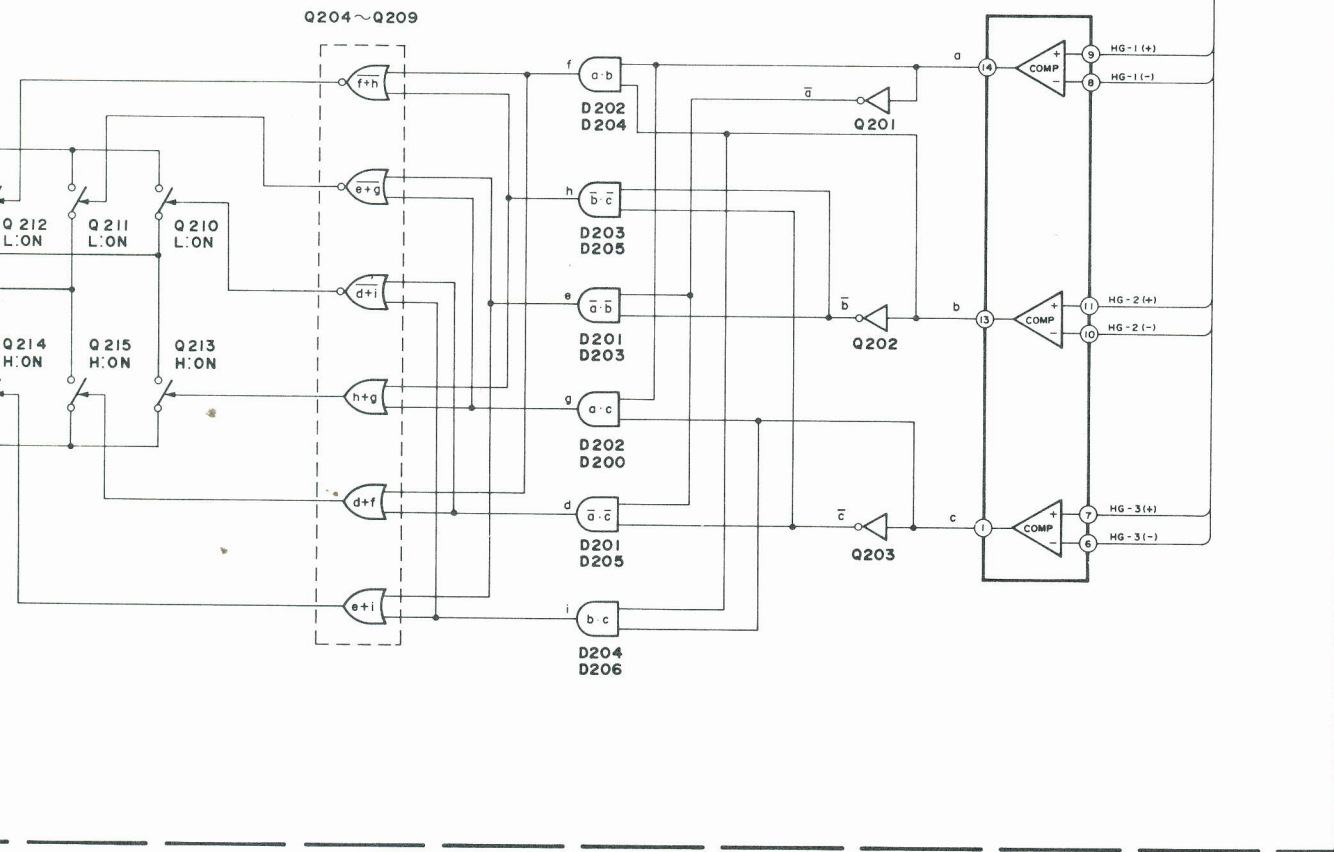

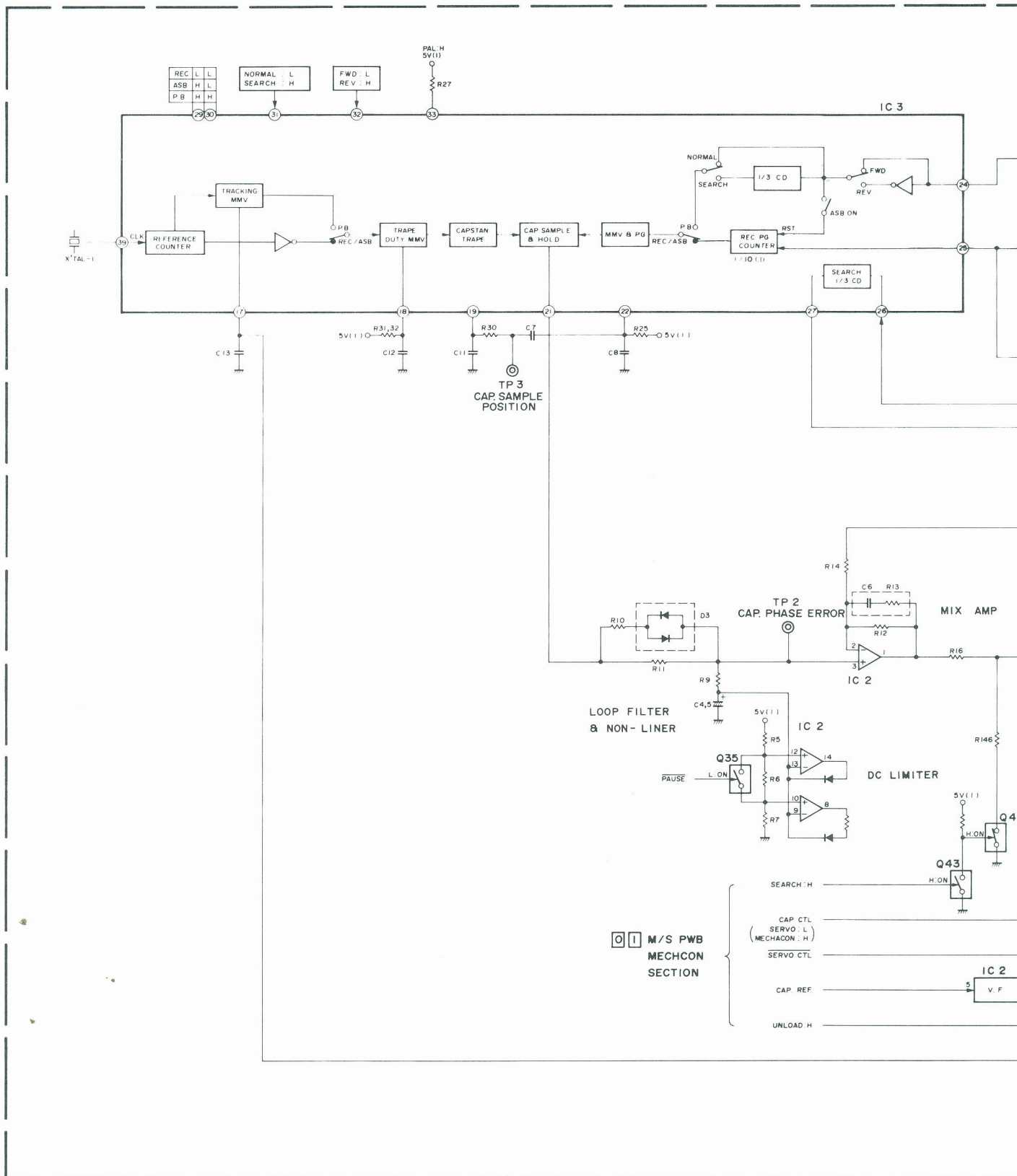

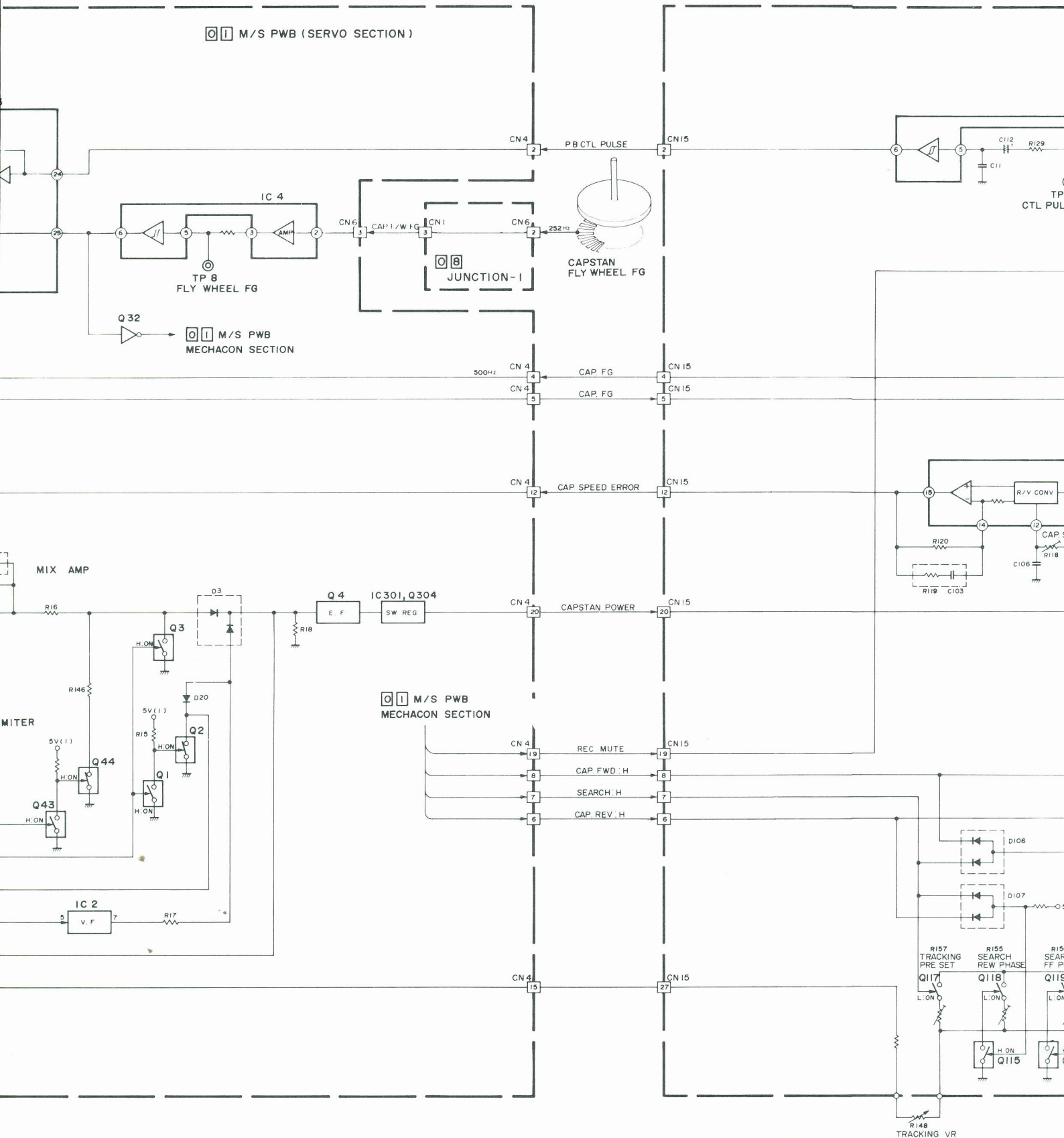

Capstanservo Blockschaltbild

Capstan servo block diagram

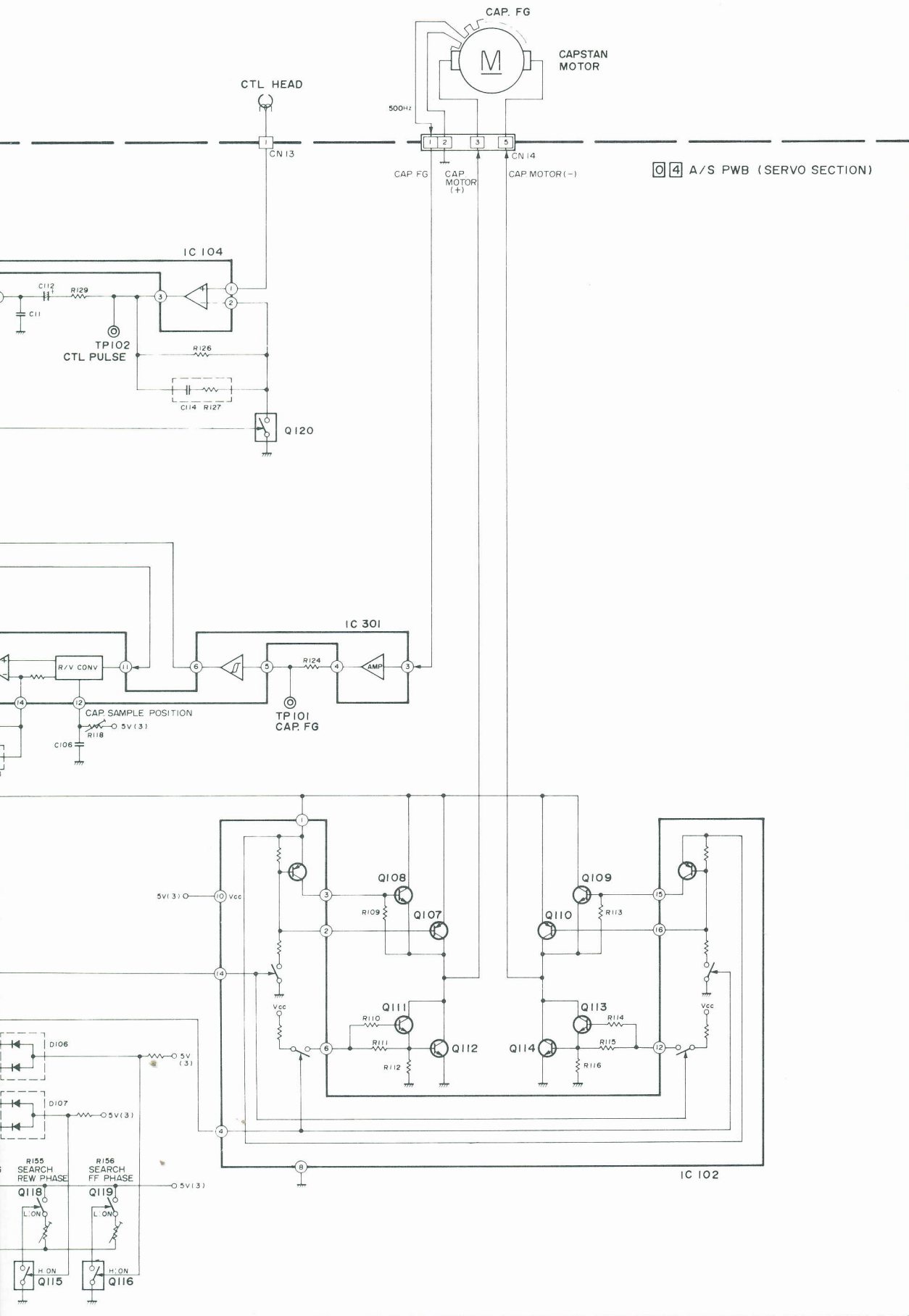

Capstan servo Impulsdiagramm

Capstan servo timing chart

Aufnahme
REC mode

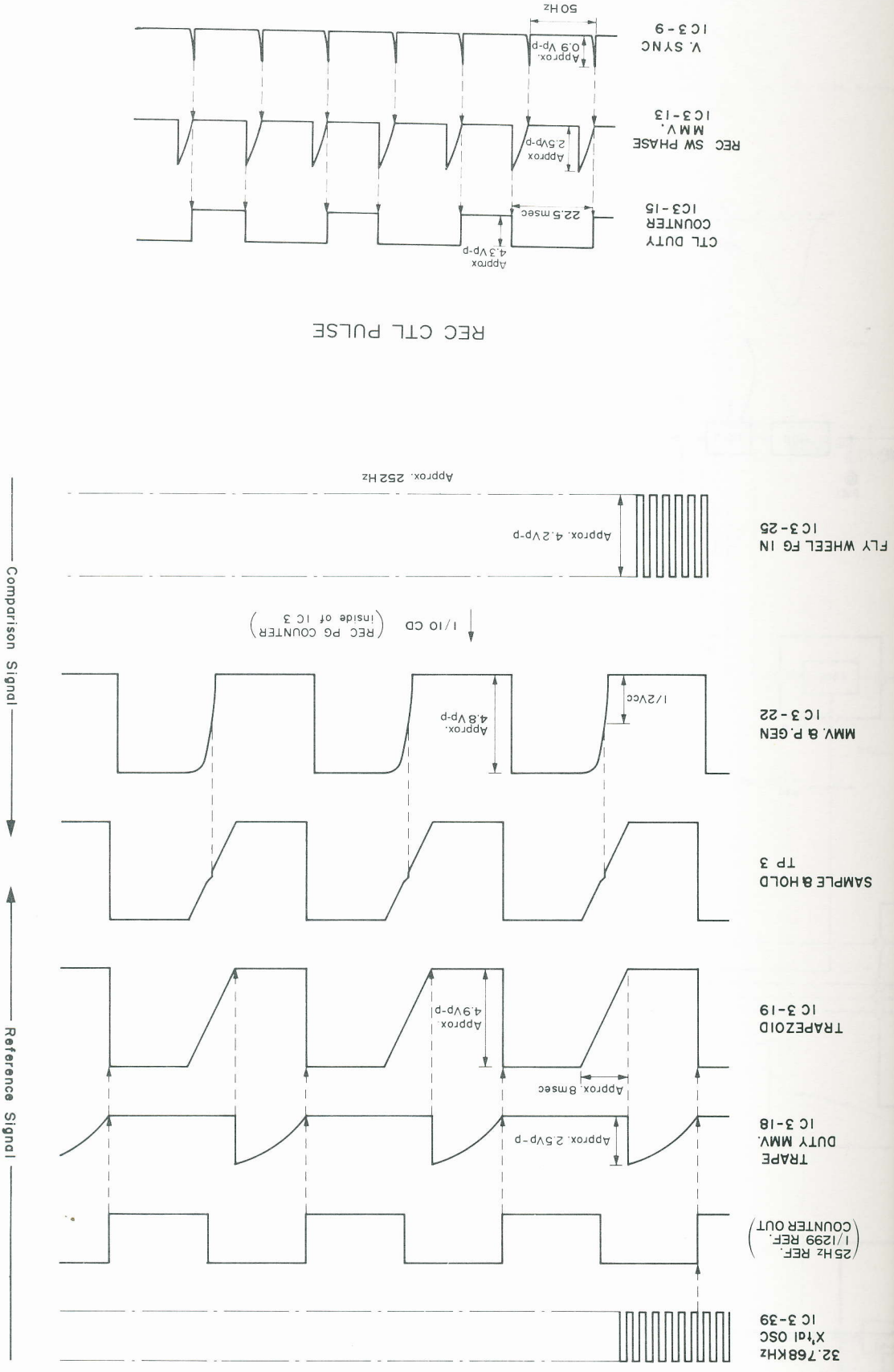

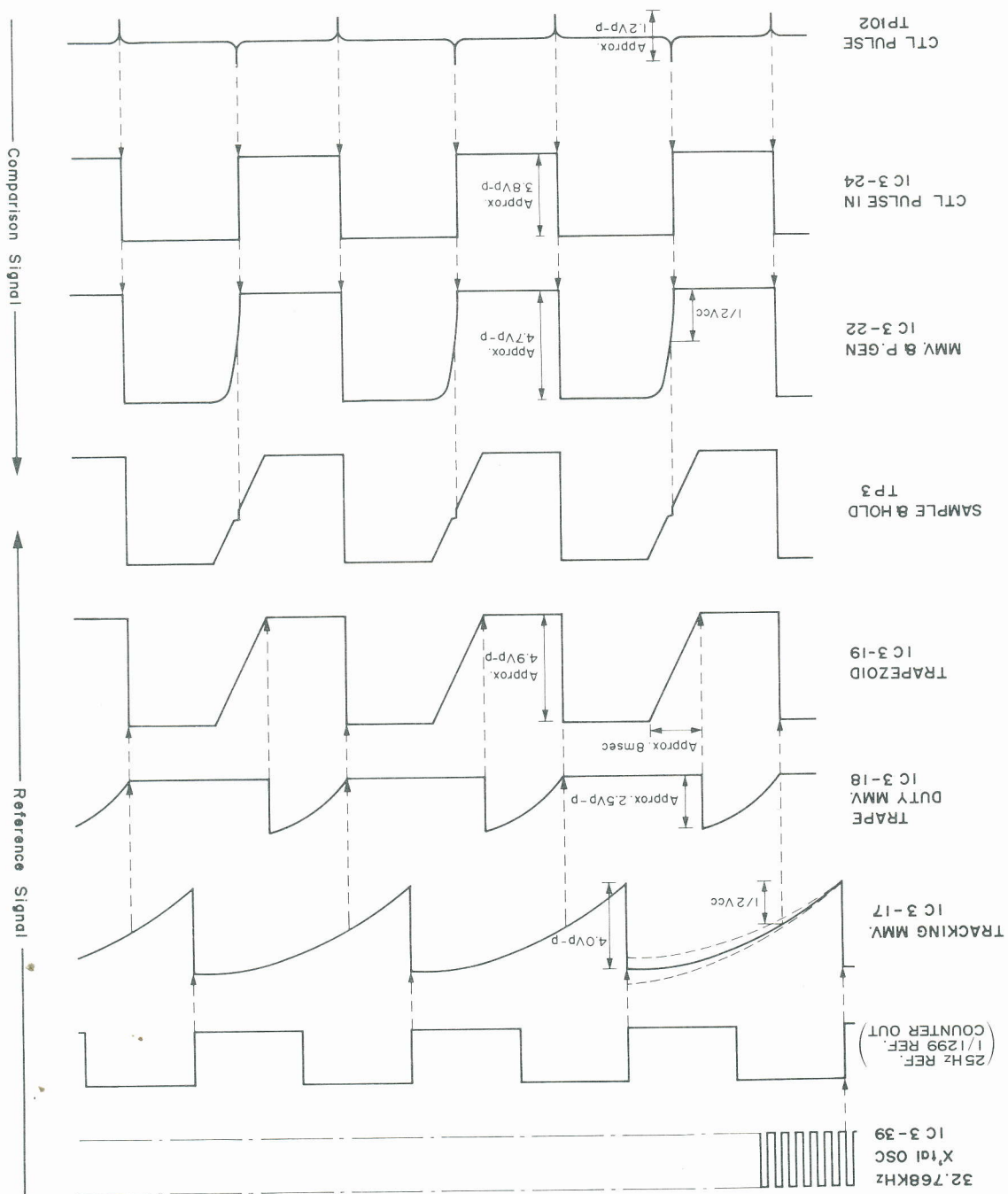

Wiedergabe P.B. mode

Assembly-Schnitt
Assembly mode

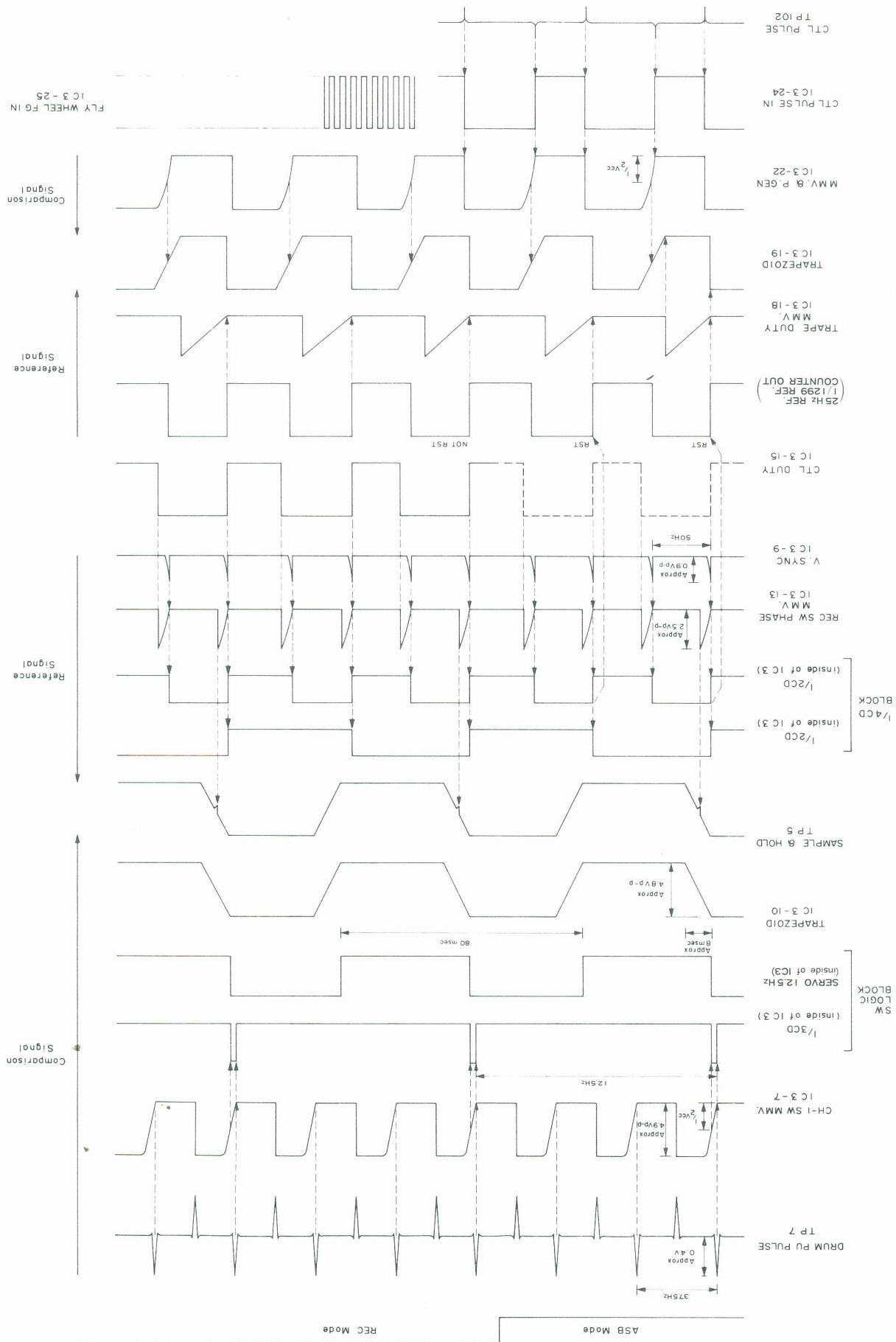

Camera Video Blockschaltbild

Camera video block diagram

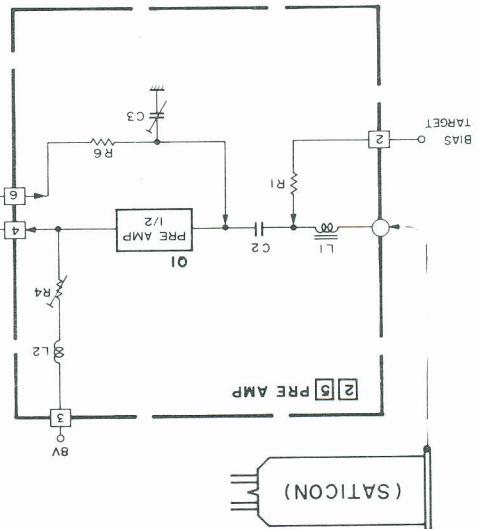
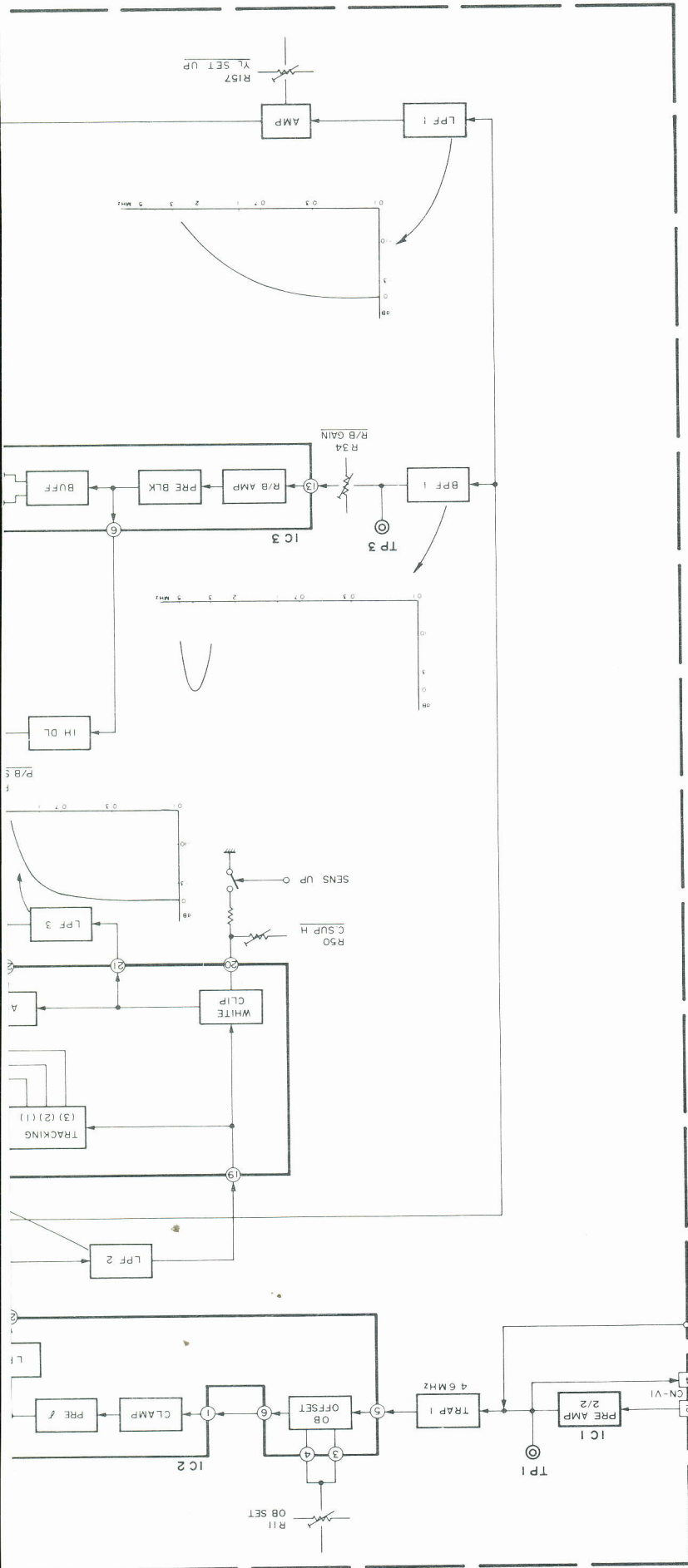

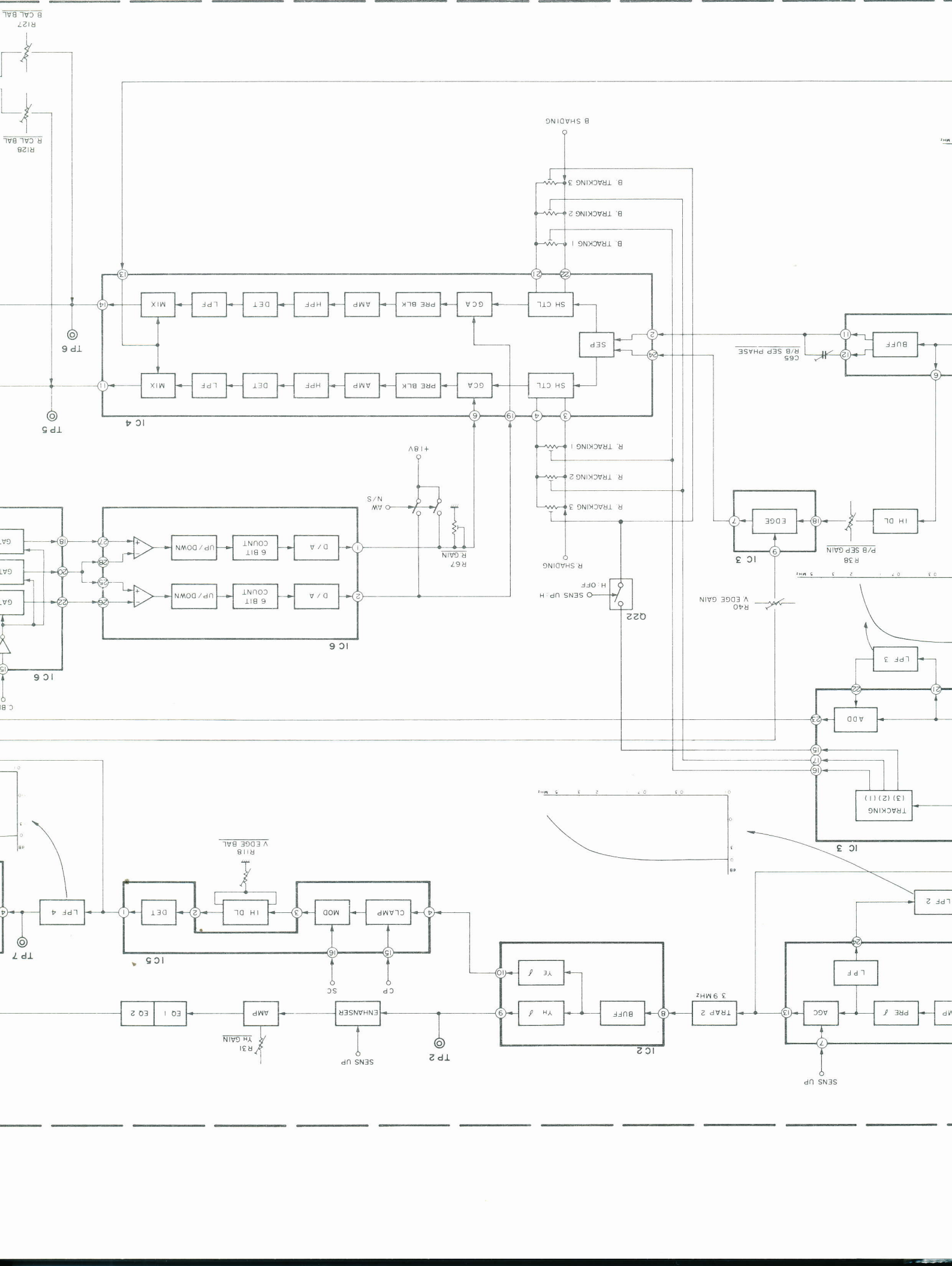
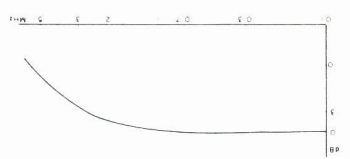
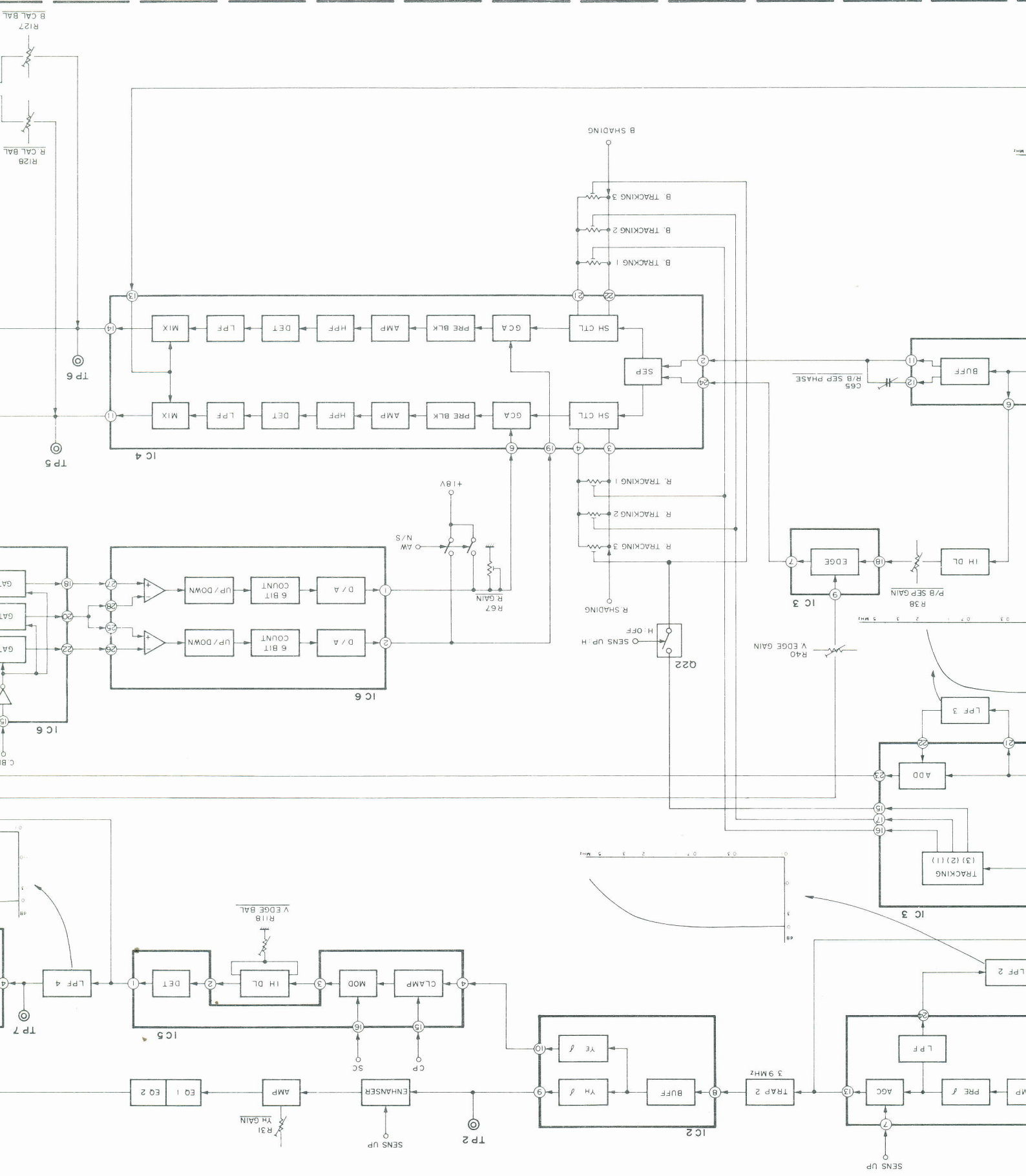

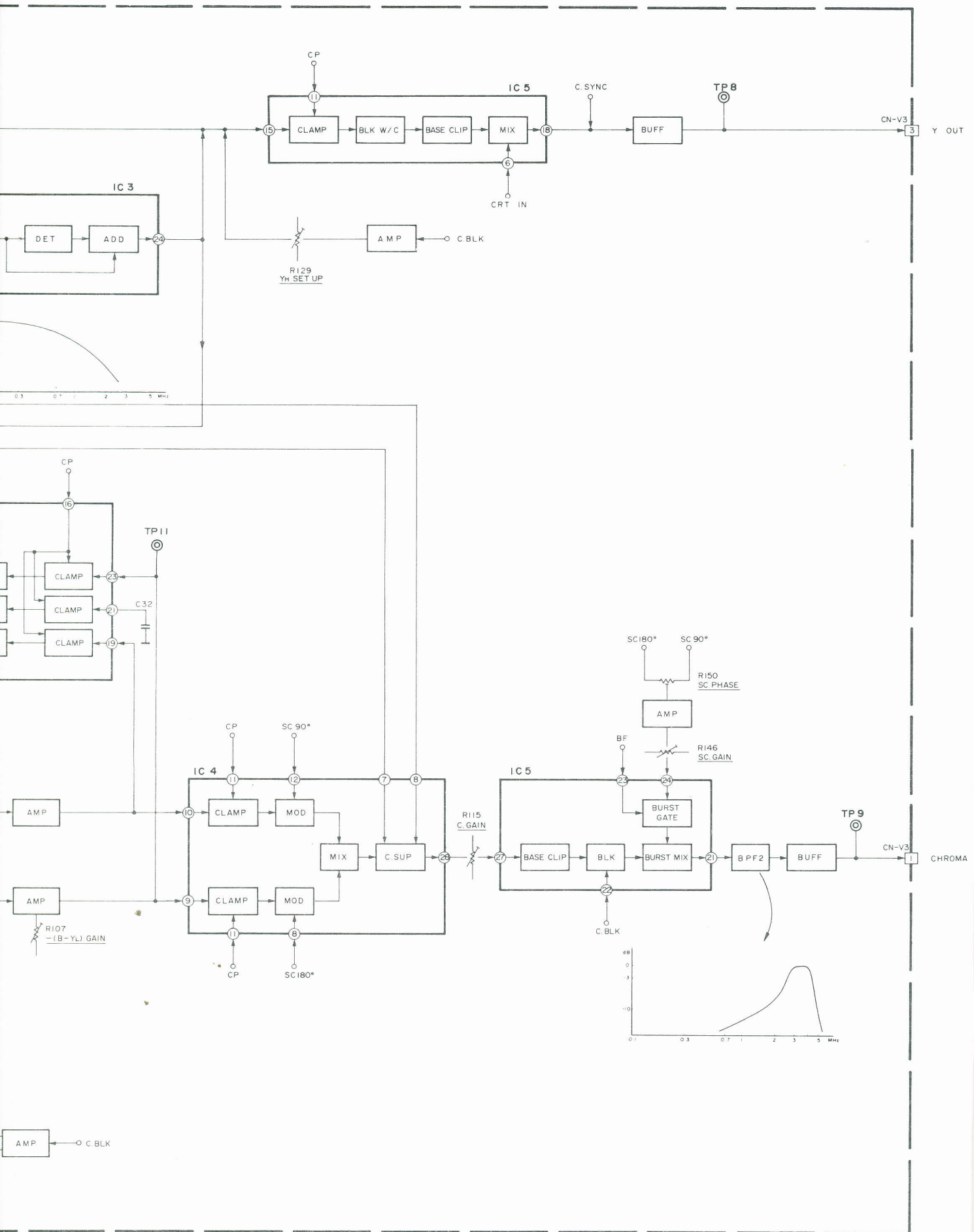

04 AUDIO/SERVO (AUDIO SECTION)

Q5 A-5D
2SD601

IC 1
BA5112LS

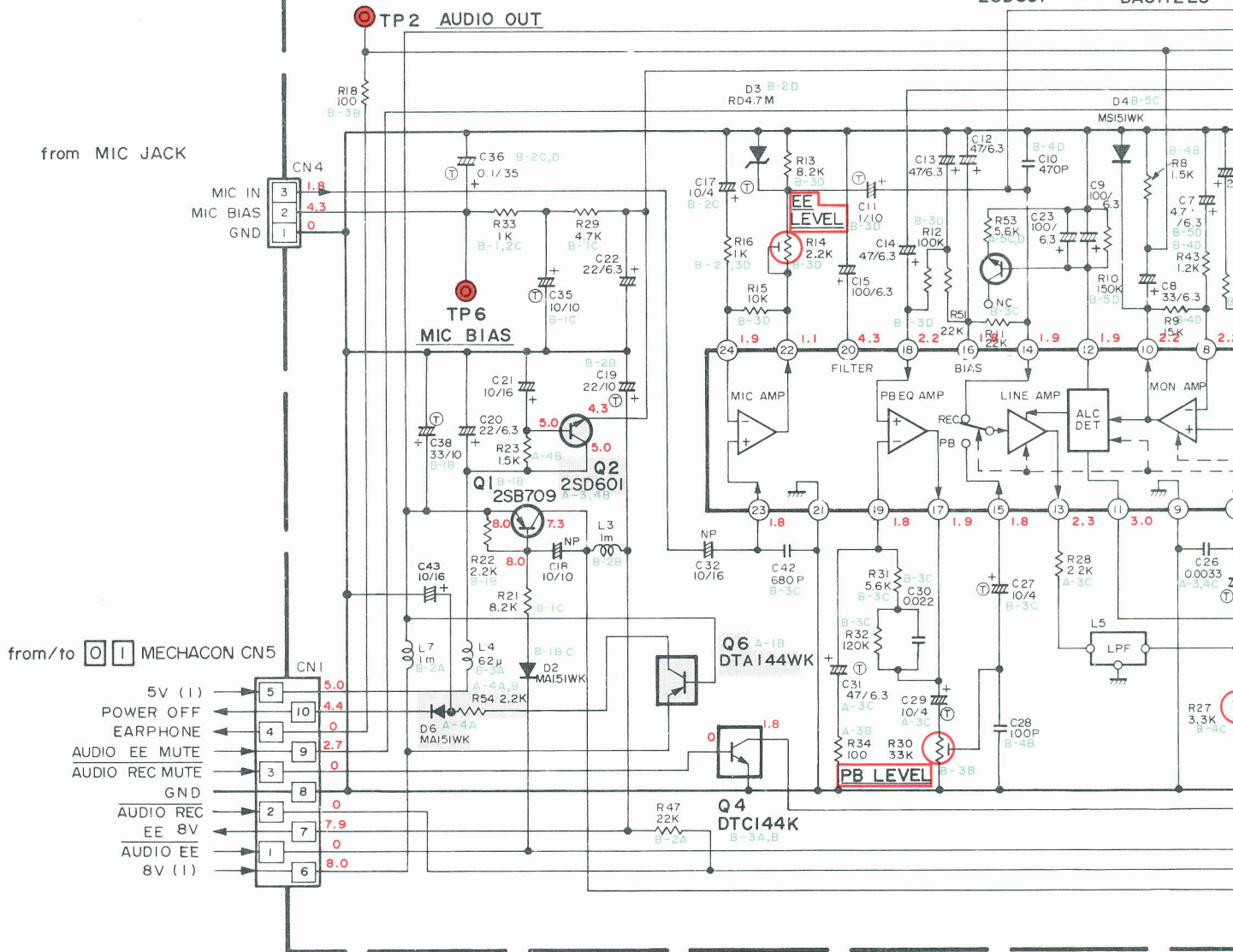

8 7 6 5 4 3

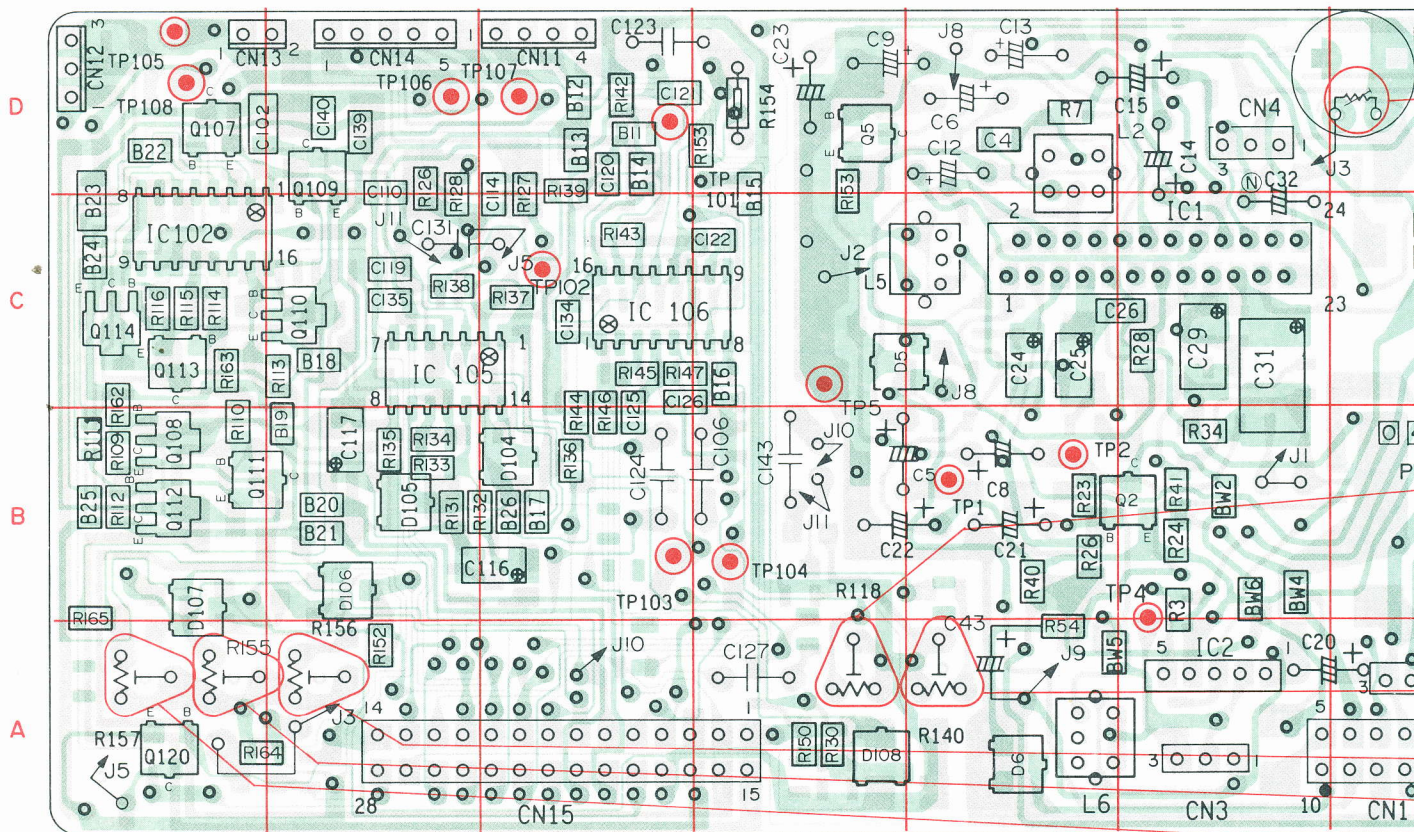

8 7 6 5 4 3 37

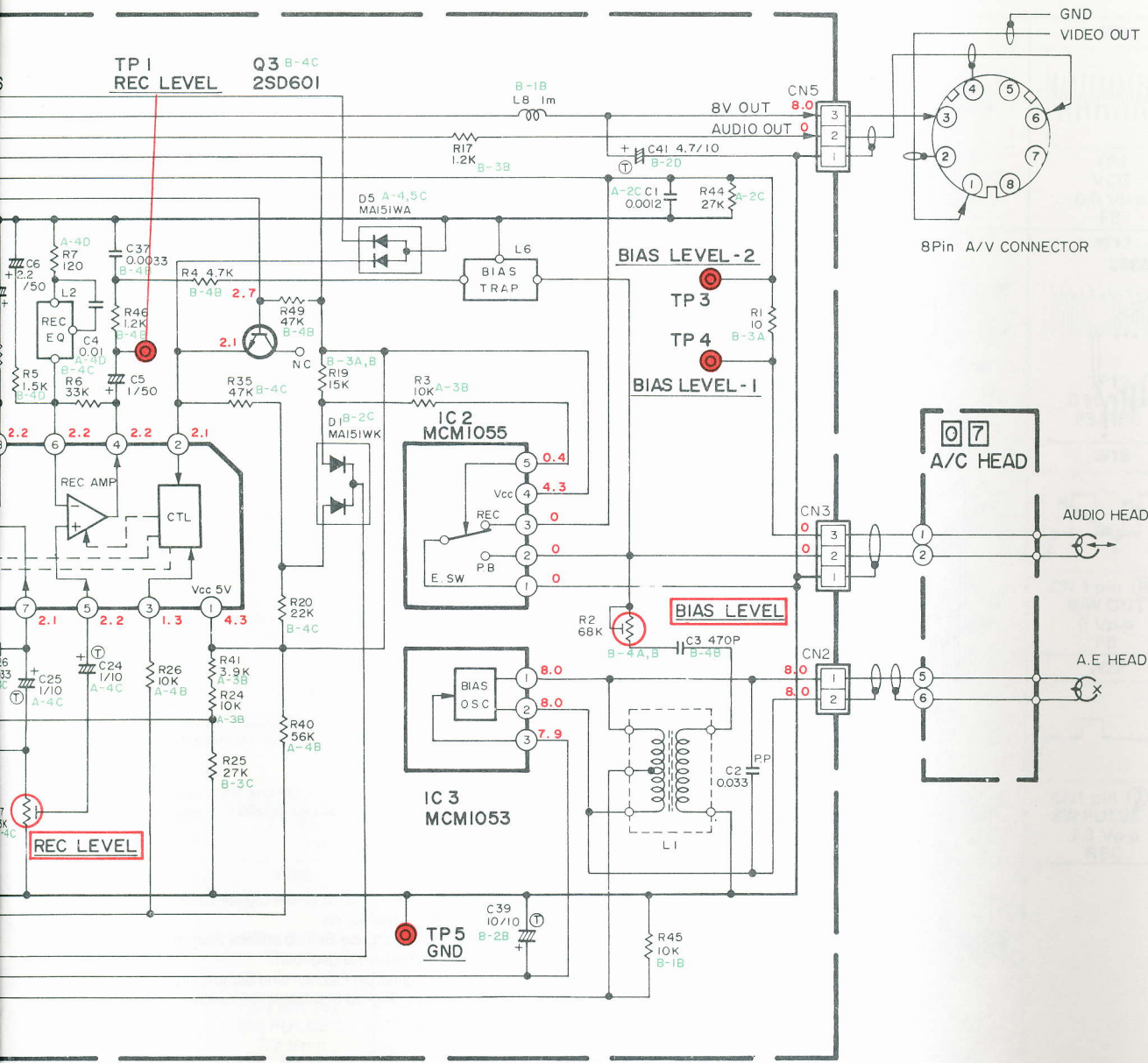

IC1 CTL MOD

IC1 pin (2)	REC/PB CTL
IC1 pin (3)	MUTE CTL
	MIC AMP
	PB. EQ AMP
	REC/PB SW
	MON AMP
	REC AMP
	LINE AMP

- NOTES: Unkl
1. All resi
 2. All ind
 3. All cap
- : Ch
 : El
 : Ta
 : Tol
 : DC Voltage stop mode
- Hinweis:
1. Alle Gleichspa ohne Signal g
 2. Bauteile in der Nur gegen Ori

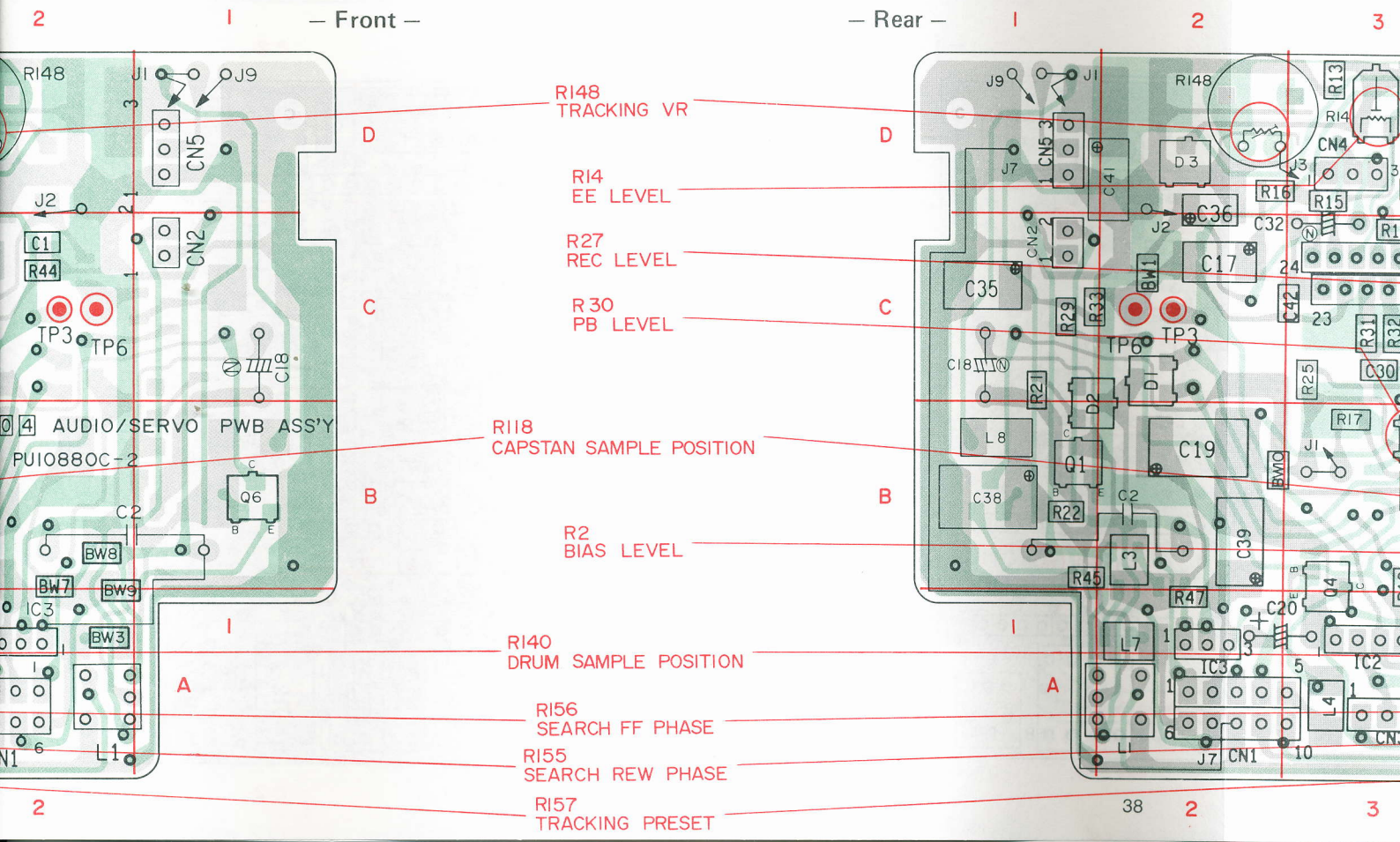

Audio-Schaltbild Audio circuit diagram

IC1 CTL MODE

	REC	EE/REC MUTE	PB	PB MUTE
IC1 pin ② REC/PB CTL	L	L	H	H
IC1 pin ③ MUTE CTL	L	H	L	H
MIC AMP	ON	ON	ON	ON
PB EQ AMP	ON	ON	ON	ON
REC/PB SW	REC	REC	PB	PB
MON AMP	ON	ON	ON	OFF
REC AMP	ON	OFF	OFF	OFF
LINE AMP	ON	ON	OFF	OFF

NOTES: Unless otherwise specified.

- All resistance values are in ohms.
- All inductance values are in H.
- All capacitance values are in μF .
 - : Chip capacitor
 - : Mylar capacitor
 - : Electrolytic capacitor
 - : Non-polar capacitor
 - : Tantalum capacitor
 - : Polypropylene capacitor
- Shaded () parts are critical for safety. Replace only with specified part numbers.
- The digital transistor is a transistor that includes built in resistors. Both PNP and NPN transistors are available.



- DC voltages are measured with a digital voltmeter during stop mode without a signal.

Hinweis:

- Alle Gleichspannungen sind mit einem Digital-Voltmeter im Stop-Betrieb ohne Signal gemessen.
- Bauteile in den schattierten Flächen sind Sicherheits-Bauteile! Nur gegen Original-Ersatzteile austauschen!

BA6322F
BA6302AF

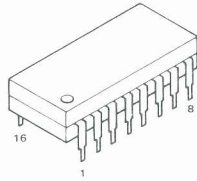

DTC144K

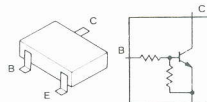

UPC451G

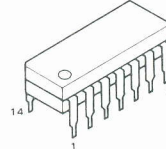

2SB709

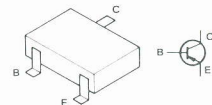

DTA124K

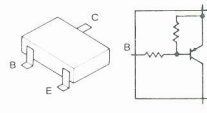

BA5112LS

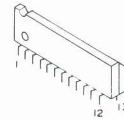

MA151WK

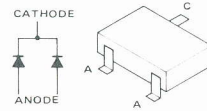

BAF6305

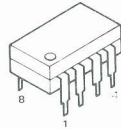

2SD601
2SD1119

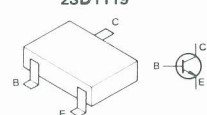

MCM1055



MA151WA

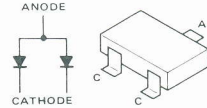

MCM1053

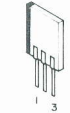

DA204K

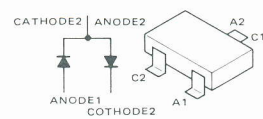

1SS133

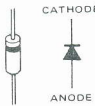

RD4.7M
RD8.2MB1
RD9.1MB2

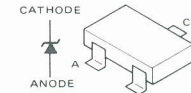

04 Audio (Servo)-Platte Audio (servo) PWB

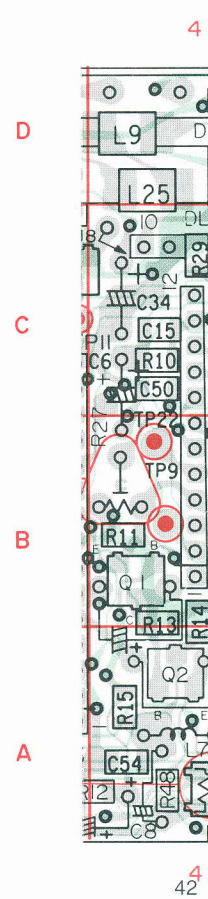
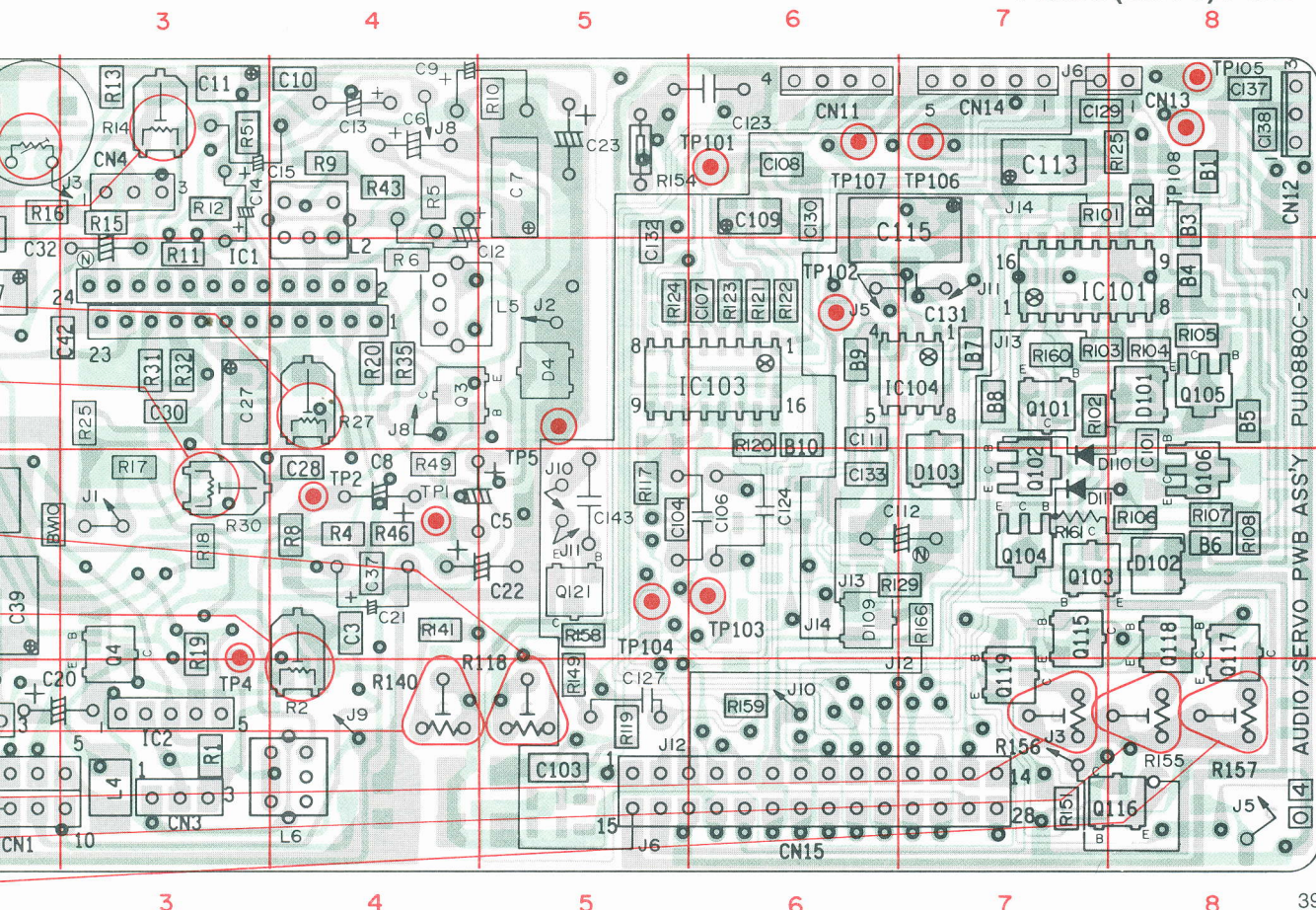

**0 2 Video-Platte (Recorder)
Video PWB (tape recorder)**

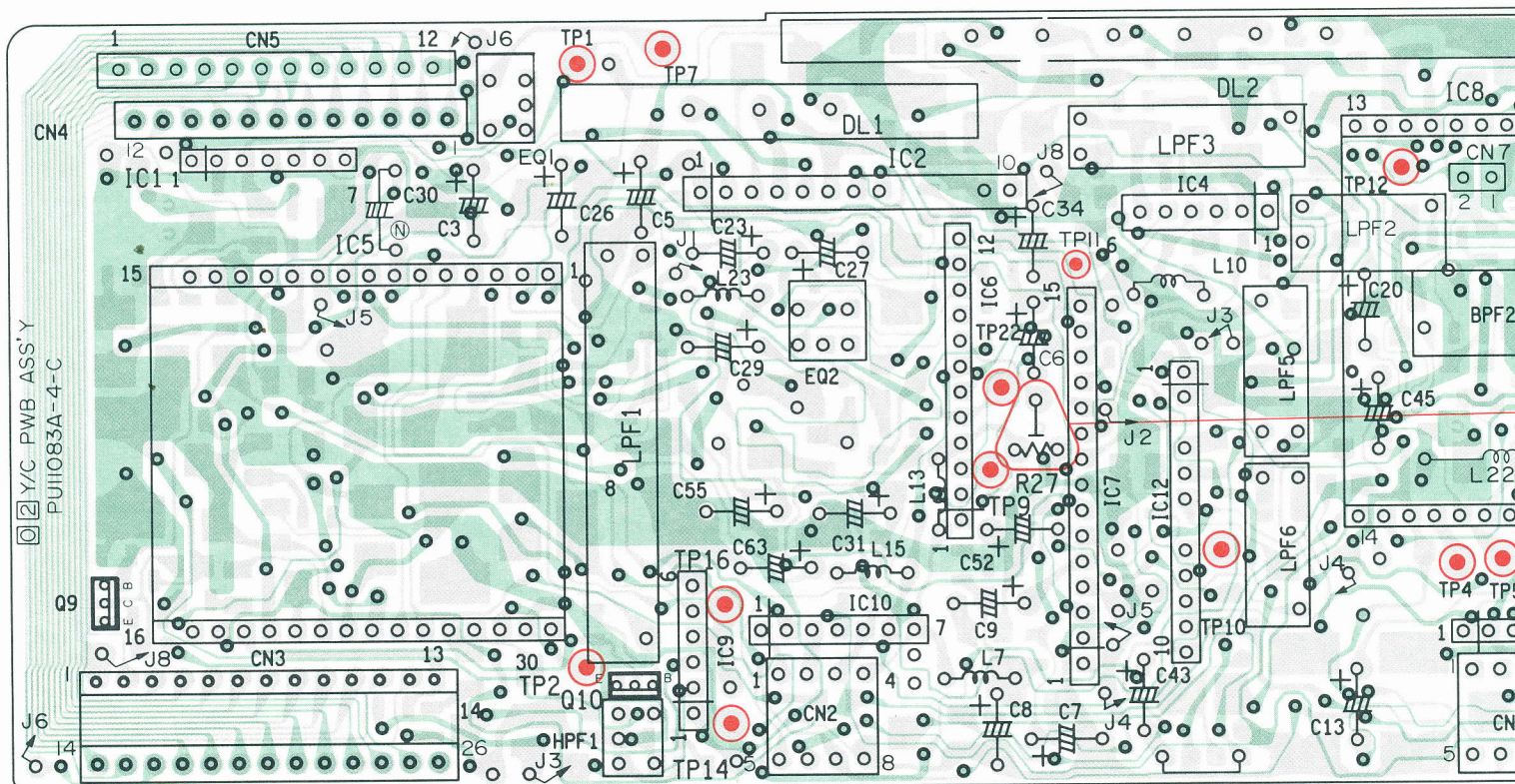
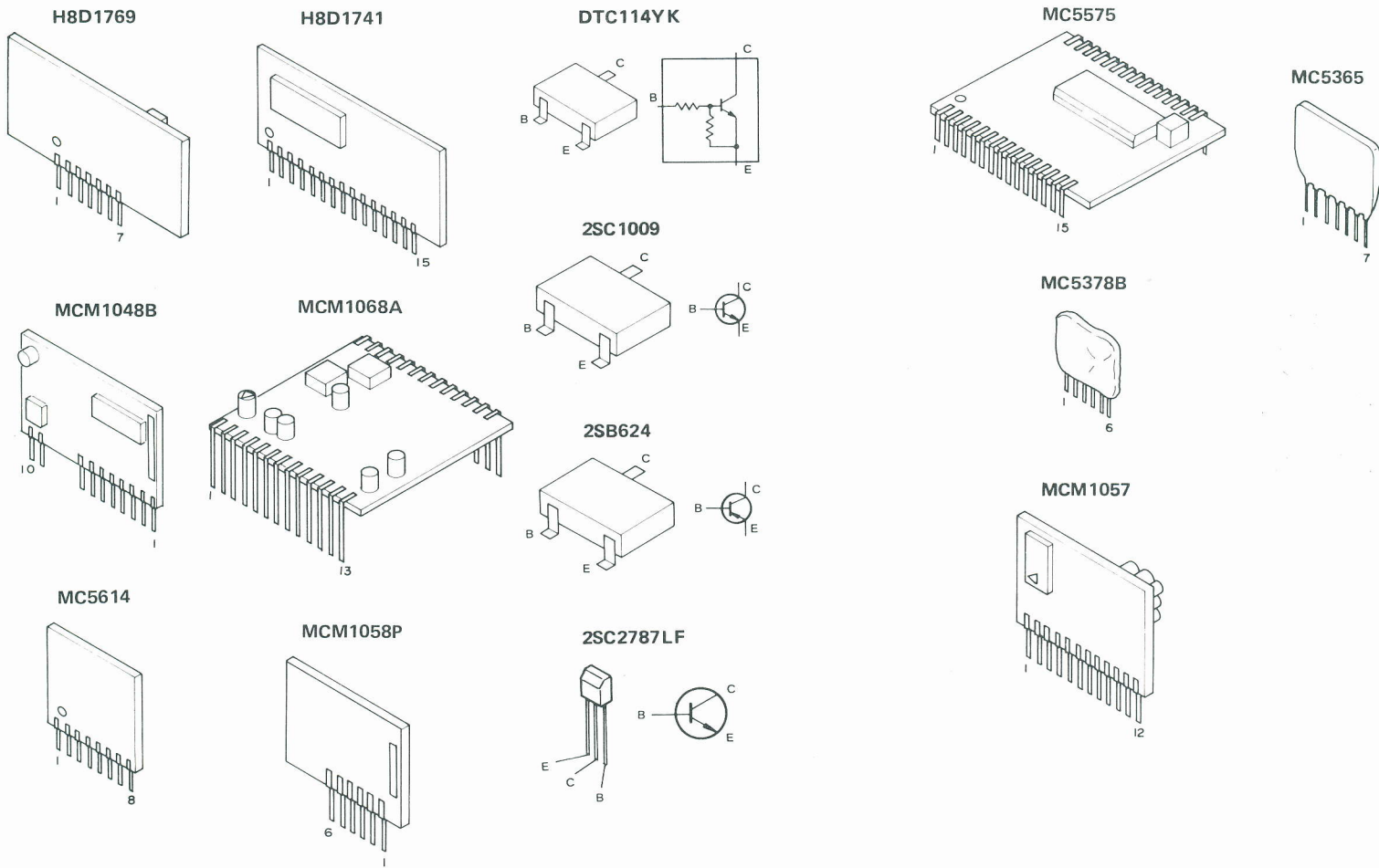

MC5365



1SS133

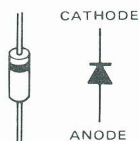

H8D1740

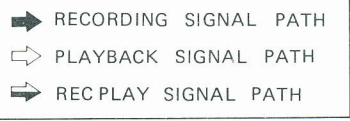
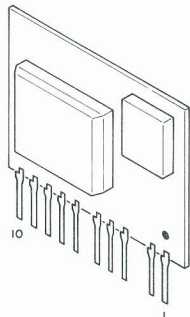

NOTES: Unless otherwise specified.

1. All resistance values are in ohms.
2. All inductance values are in H.
3. All capacitance values are in μF .

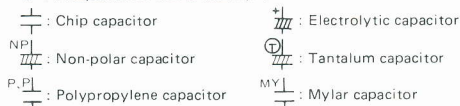

4. Shaded () parts are critical for safety. Replace only with specified part numbers.
5. The digital transistor that includes built in resistors. Both PNP and NPN transistors are available.



6. DC voltages are measured with a digital voltmeter during recording mode.
 7. Where voltage differs between recording and play-back, the voltage during play-back is shown in parentheses.
 8. Wave forms
- Recording: Measured by using "Y/C SEPARATOR" with color bar signal input.
 Play-back: Measured during play-back of color bar segment of Alignment Tape.

Hinweis:





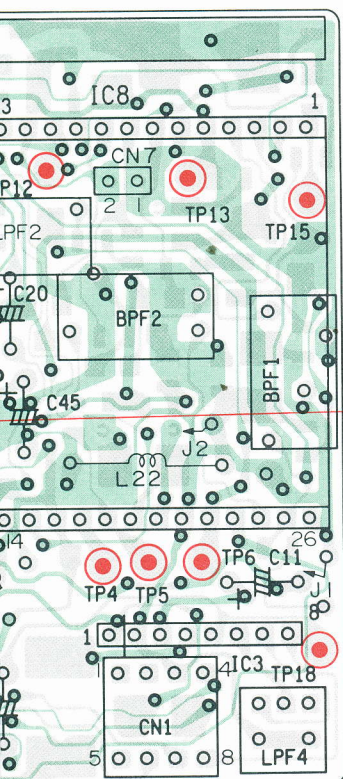



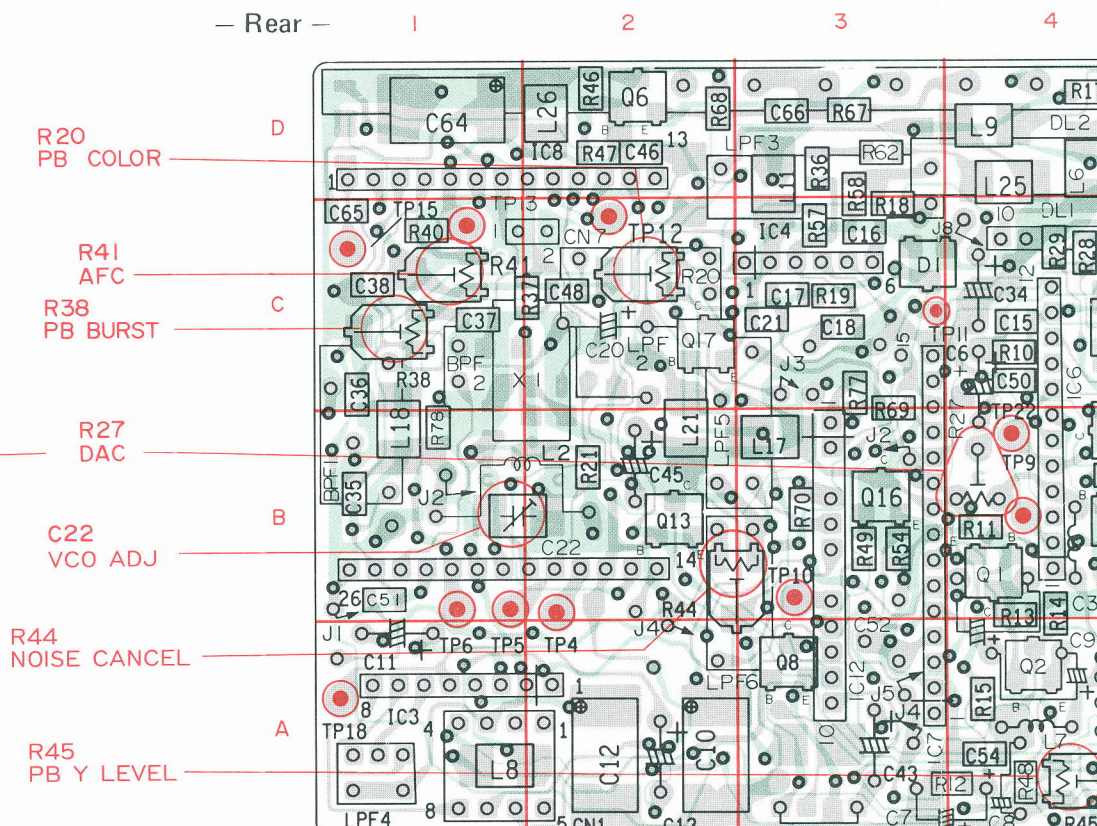

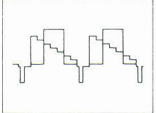
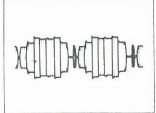
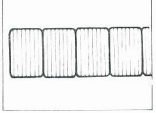
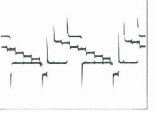
1. Alle Gleichspannungen sind mit einem Digital-Voltmeter im Aufnahmebetrieb gemessen.
2. Ergeben sich im Wiedergabe-Betrieb andere Spannungen, so sind diese in Klammern angegeben.
3. Bauteile in den schattierten Flächen sind Sicherheitsbauteile! Nur gegen Original-Ersatzteile wechseln!

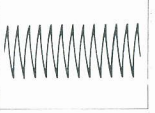
— Front —

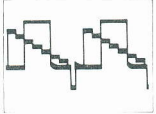
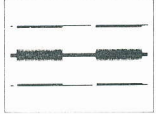
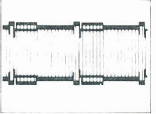

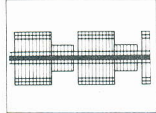
— Rear —

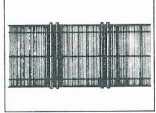
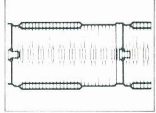
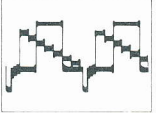
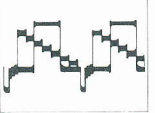
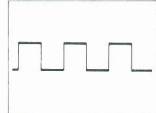
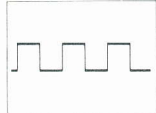
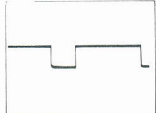
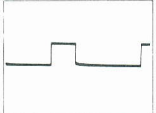
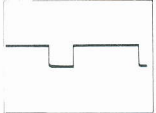
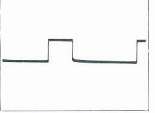
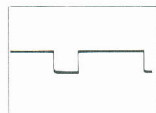
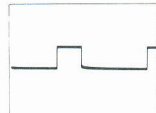
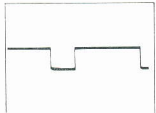
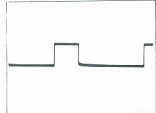

<p>W1</p>  <p>CN6 pin ② Y IN 1 Vp-p REC</p>	<p>W2</p>  <p>TP23 CHROMA IN BARST 0.2 Vp-p REC</p>	<p>W3</p>  <p>TP1 PB FM 0.28 Vp-p PB</p>	<p>W4</p>  <p>TP2 EMPHASIS 0.64 Vp-p REC</p>	<p>W5</p>  <p>TP18 VIDEO OUT 2 Vp-p PB</p>	<p>W6</p>  <p>TP4 VCO 0.5 Vp-p PB</p>
<p>W7</p>  <p>TP5 VCO OUT 0.9 Vp-p</p>	<p>W8</p>  <p>TP6 PB COLOR 0.2 Vp-p PB</p>	<p>W9</p>  <p>TP22 Y AMP IN 0.24 Vp-p REC 0.48 Vp-p PB</p>	<p>W10</p>  <p>TP9 DYAC 0.28 Vp-p REC</p>	<p>W11</p>  <p>IC7 pin ⑭ 2nd LMT IN 0.5 Vp-p PB</p>	<p>W12</p>  <p>TP12 0.55 Vp-p PB/REC</p>
<p>W13</p>  <p>TP14 REC COLOR 75 mVp-p REC</p>	<p>W14</p>  <p>TP15 AFC ERROR 2.6 V DC PB</p>	<p>W15</p>  <p>IC5 pin ⑭ FM MOD OUT 0.8 Vp-p REC</p>	<p>W16</p>  <p>TP16 REC FM 3.6 Vp-p REC</p>	<p>W17</p>  <p>IC5 pin ⑥ PB AMP-1 IN 0.36 Vp-p PB</p>	<p>W18</p>  <p>CN 1 pin ⑧ B/W OUT 2 Vp-p PB</p>
<p>W19</p>  <p>CN1 pin ① FF 25 4.0 Vp-p</p>	<p>W20</p>  <p>CN 1 pin ② FF 12.5 3.8 Vp-p</p>	<p>W21</p>  <p>CN 1 pin ⑥ SW PULSE 4 7.3 Vp-p PB</p>	<p>W21</p>  <p>CN1 pin ⑥ SW PULSE 4 7.3 Vp-p REC</p>	<p>W22</p>  <p>CN1 pin ③ SW PULSE 2 7.3 Vp-p PB</p>	<p>W22</p>  <p>CN1 pin ③ SW PULSE 2 7.3 Vp-p REC</p>
<p>W23</p>  <p>CN1 pin ④ SW PULSE 1 7.3 Vp-p PB</p>	<p>W23</p>  <p>CN1 pin ④ SW PULSE 1 7.3 Vp-p REC</p>	<p>W24</p>  <p>CN1 pin ⑦ SW PULSE 3 7.3 Vp-p PB</p>	<p>W24</p>  <p>CN1 pin ⑦ SW PULSE 3 7.3 Vp-p REC</p>	<p>W25</p>  <p>TP10 NOISE CANCEL PB</p>	

4 5 6 7 8

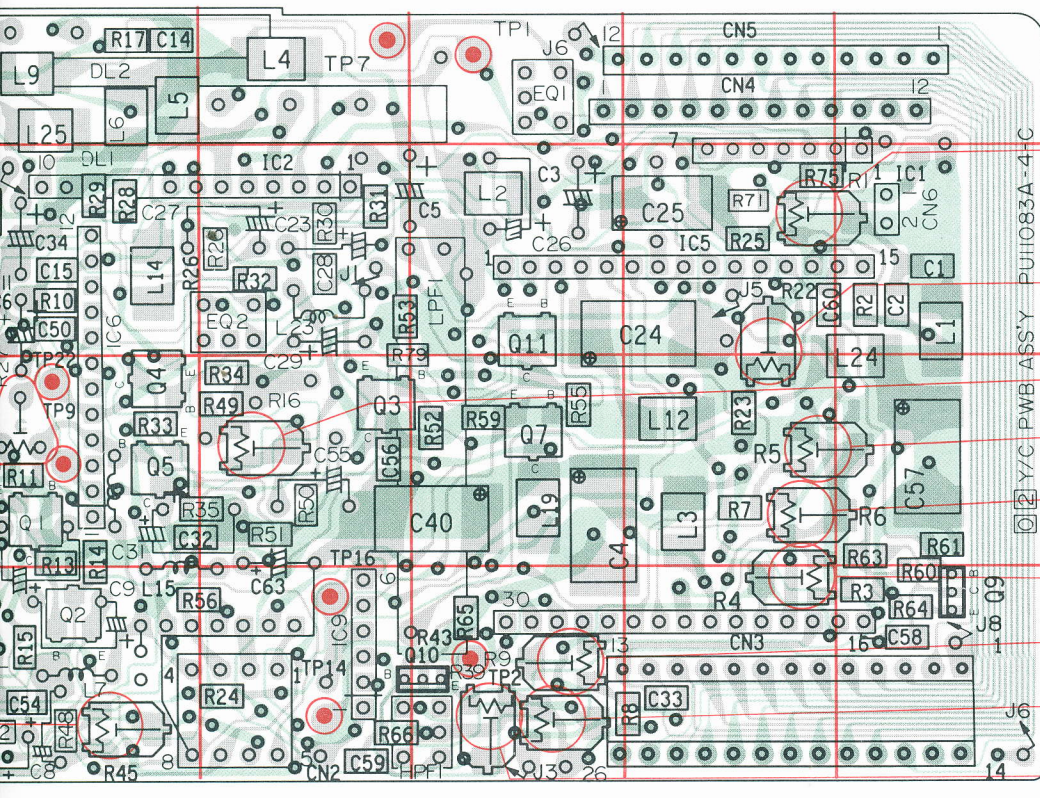

- R1 RF EQ
- R22 E-E LEVEL
- R16 E-E COLOR LEVEL
- R5 CARRIER
- R6 DEV
- R4 WHITE CLIP
- R9 DARK CLIP
- R39 REC COLOR LEVEL
- R43 REC FM

4 5 6 7 8

Video-Schaltbild (Recorder) Video circuit diagram (tape recorder)

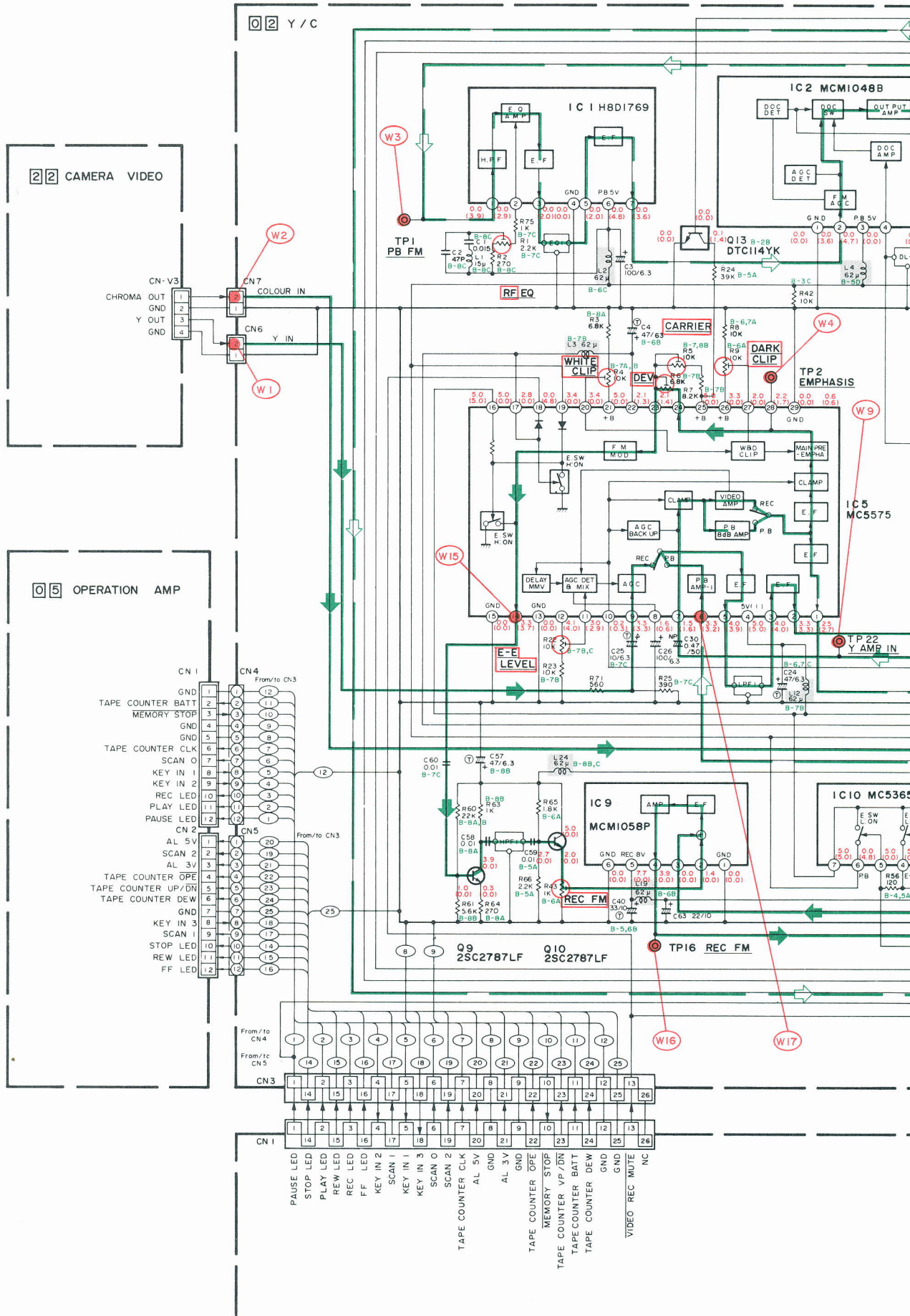

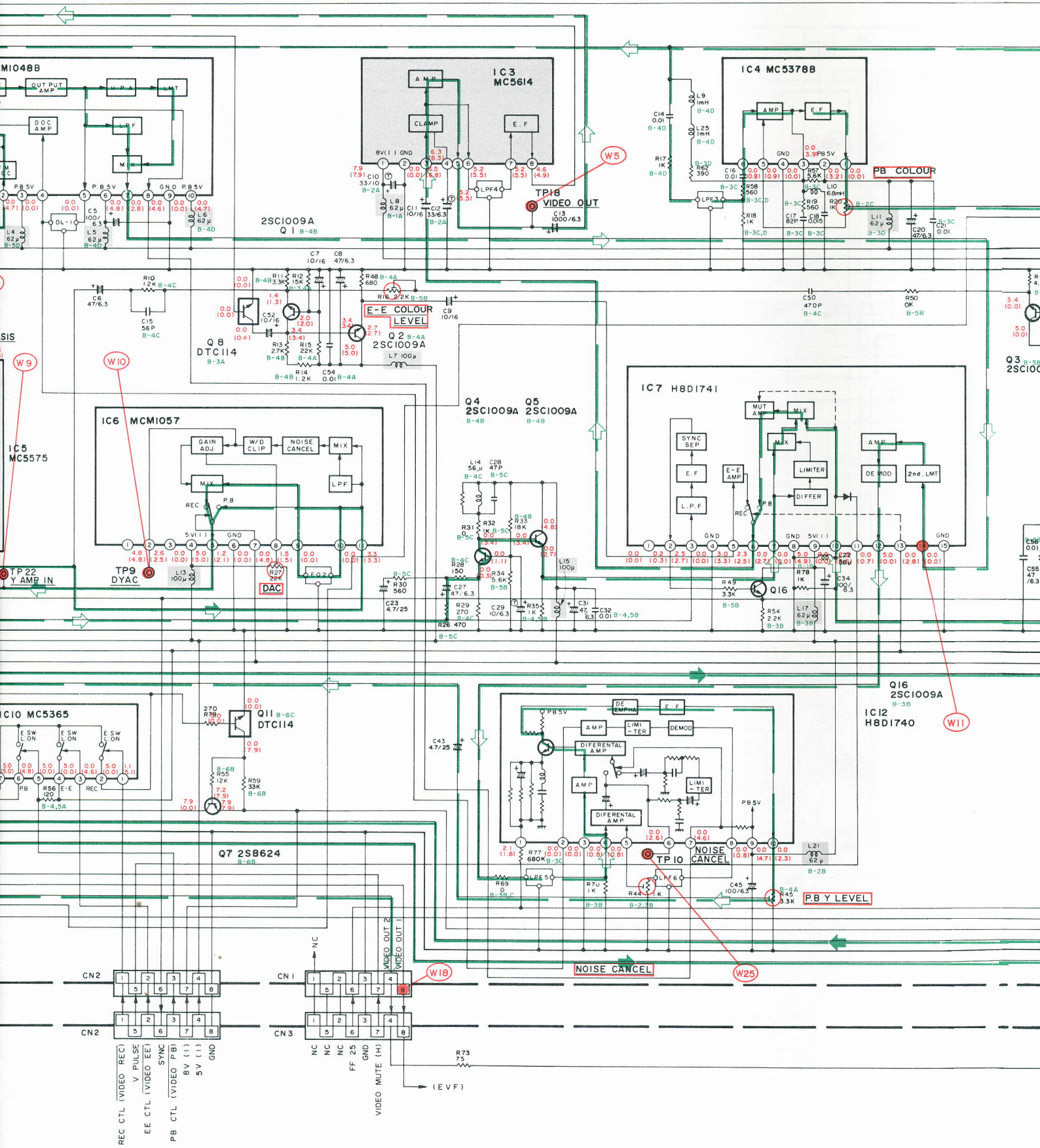

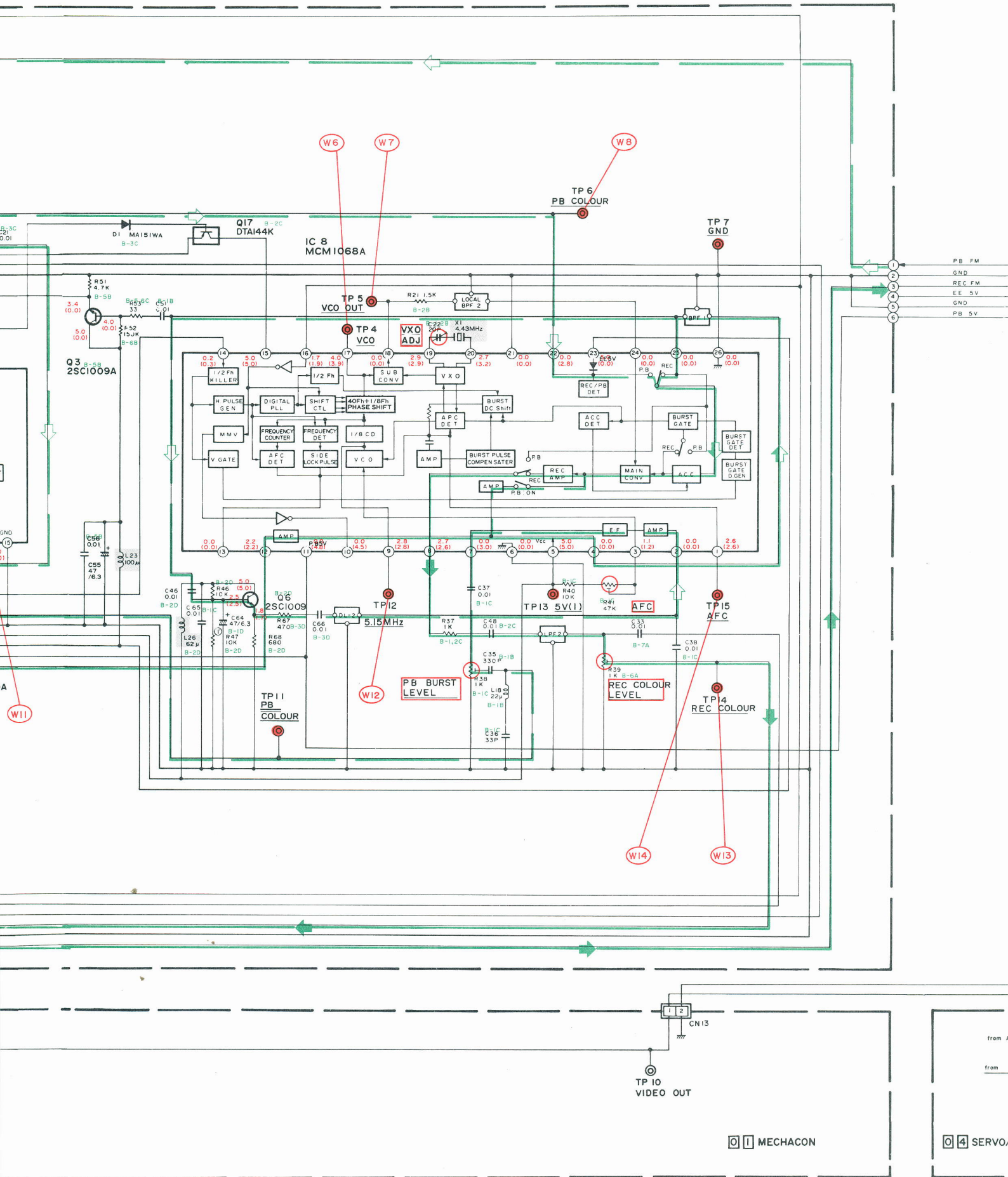

MECHACON

SERVO

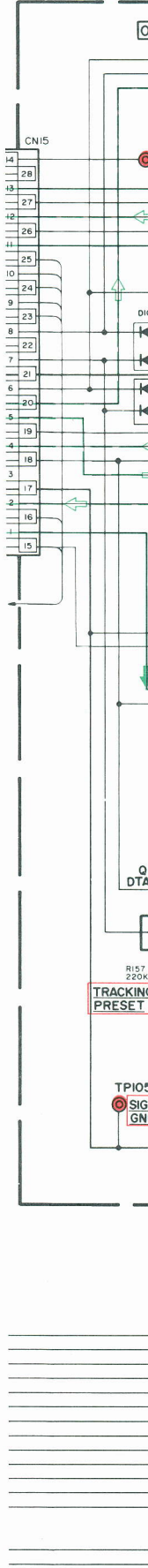
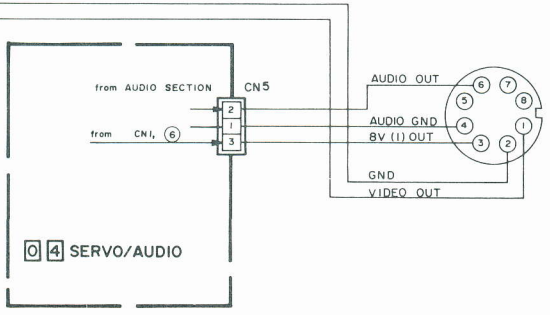
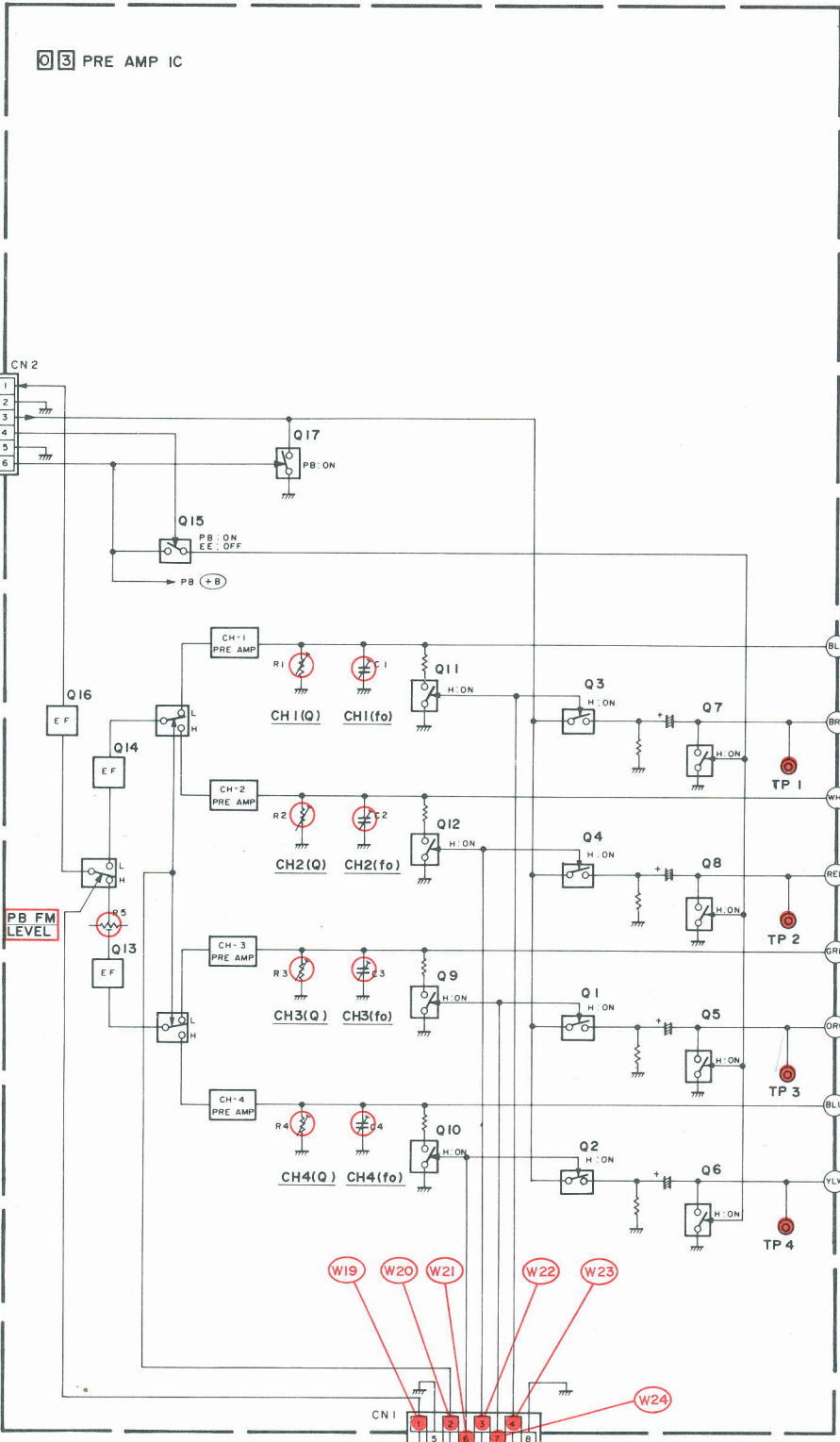

Servo-Regelung Schaltbild

Servo circuit diagram

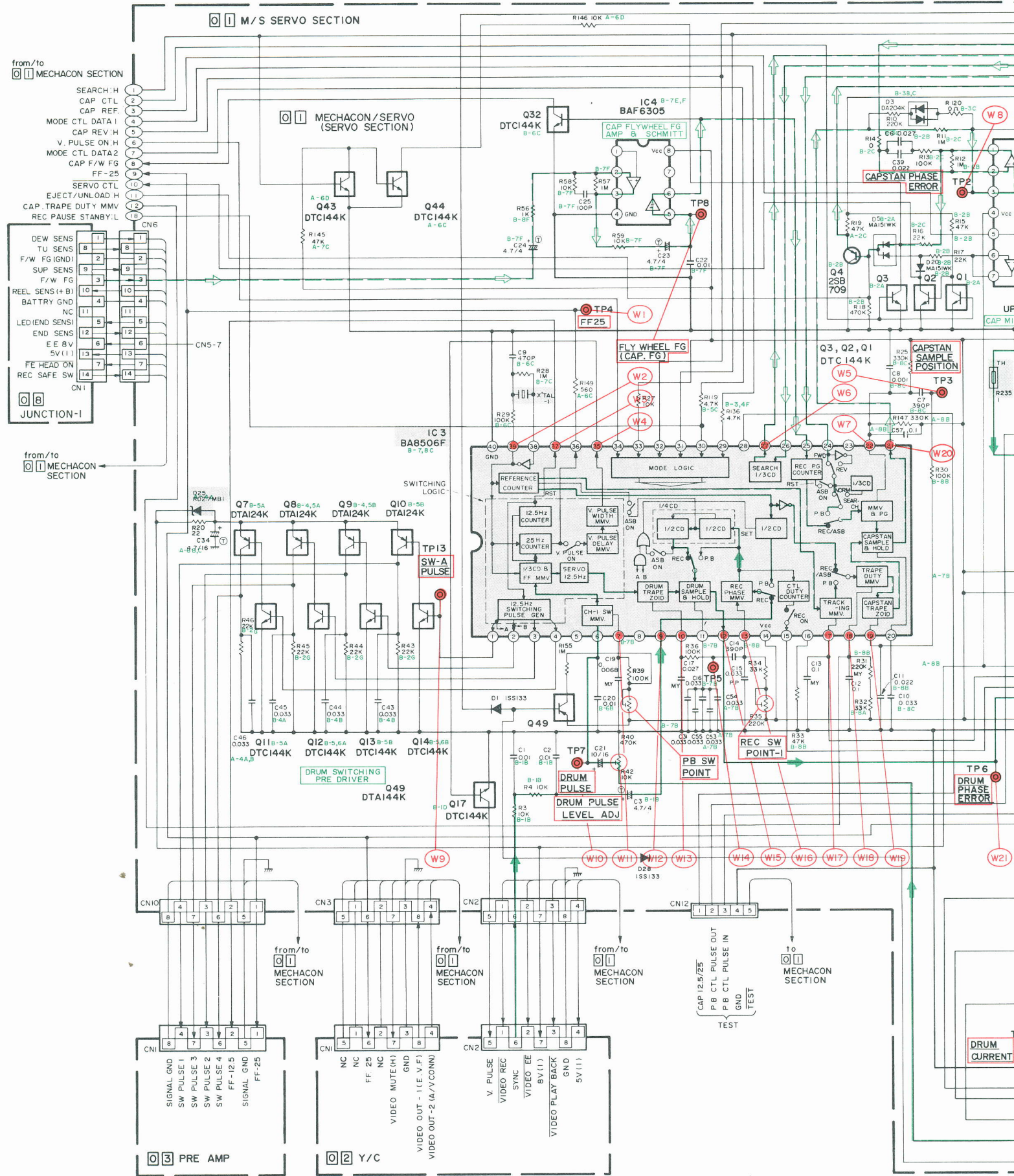

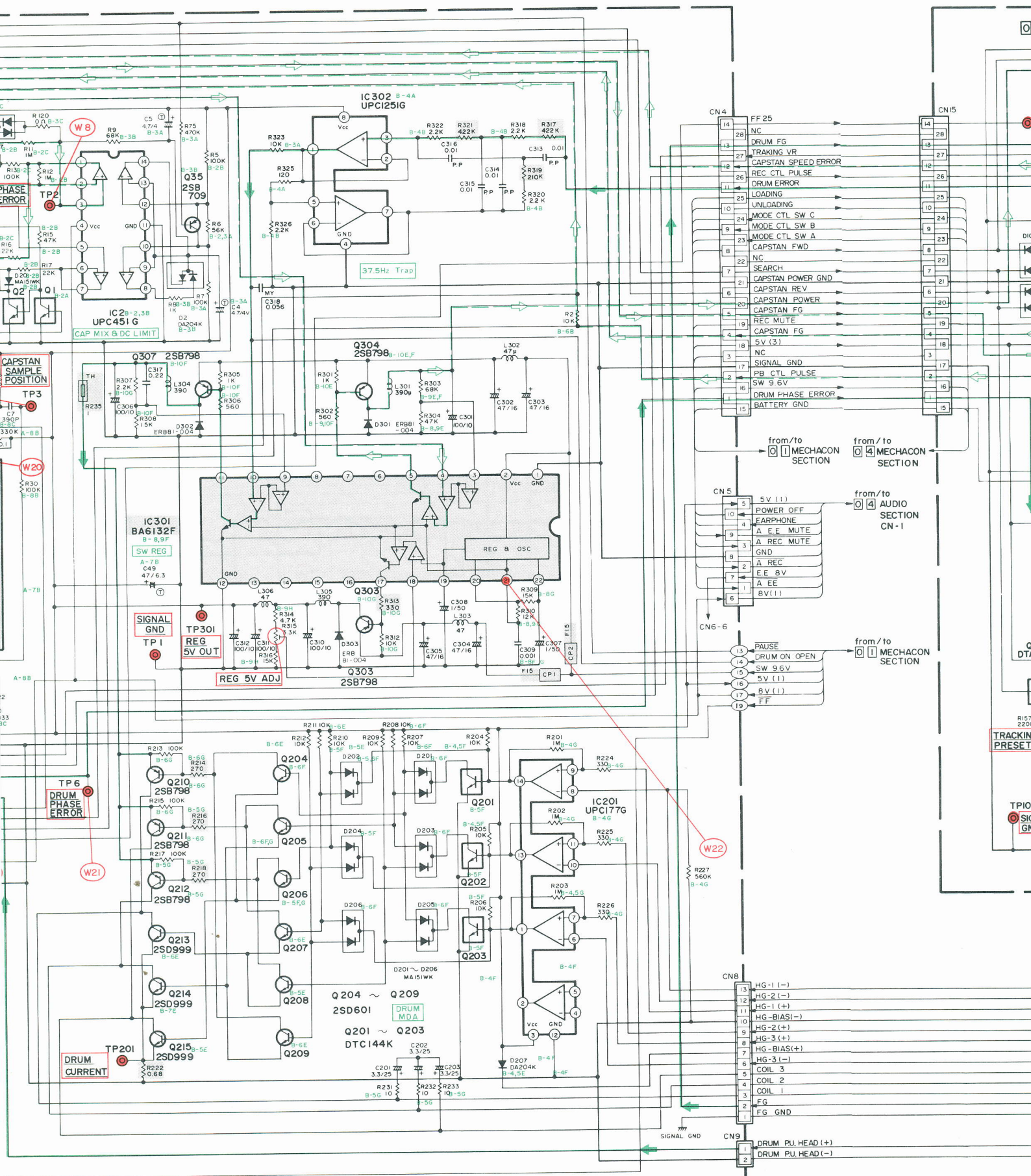

4 AUDIO / SERVO (SERVO SECTION)

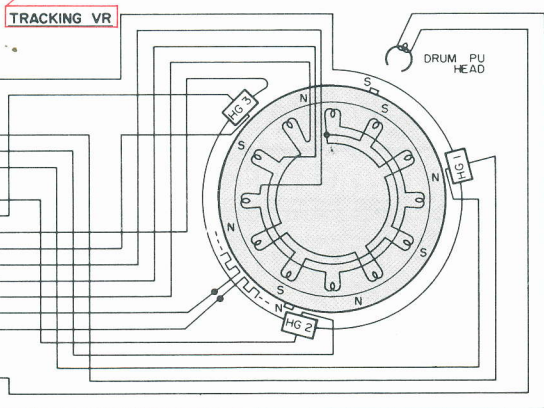
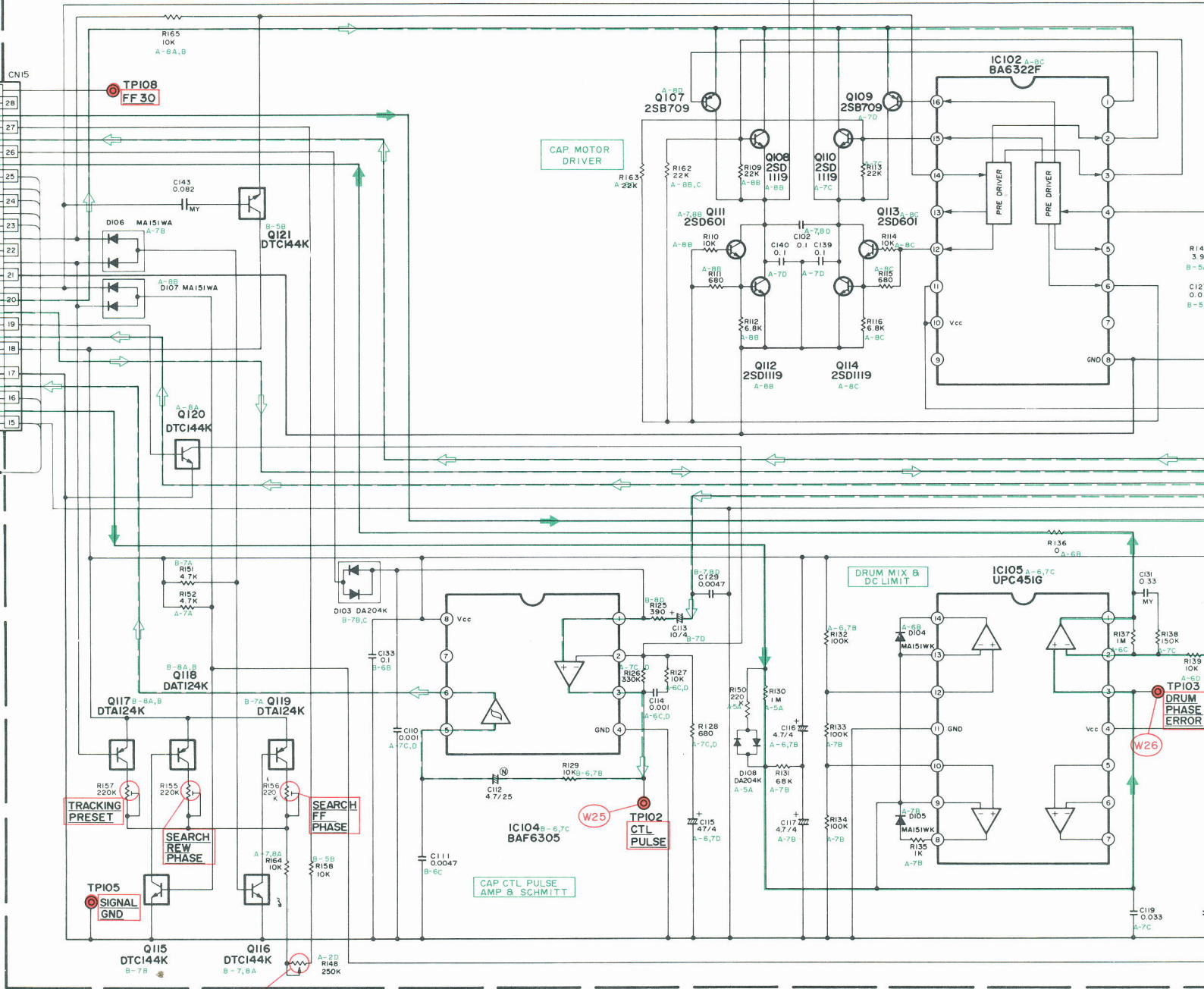

NOTES: Unless otherwise specified:

1. All resistance values are in Ω , $k\Omega$, or $M\Omega$.
2. All inductance values are in μH .
3. All capacitance values are in pF , nF , or μF .
4. Shaded () parts are optional.
5. The digital transistor is a PNP or NPN type.

➔ DRUM SERVO SIGNAL PATH
➔ CAPSTAN SERVO SIGNAL PATH

⊞ : Chip capacitor
⊞ : Electrolytic capacitor
⊞ : Tantalum capacitor

Servo-Regelung Schaltbild

Servo circuit diagram

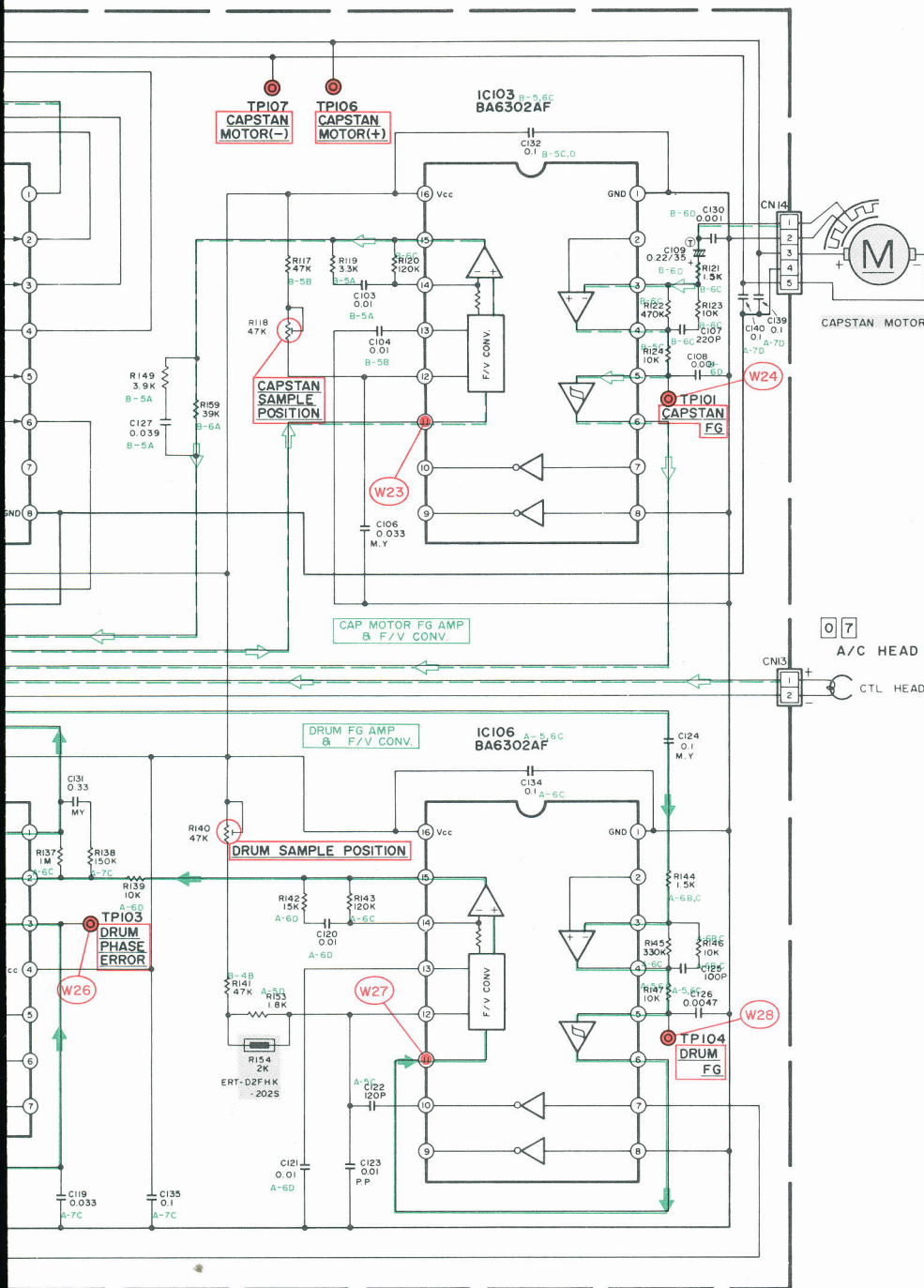

<p>W1</p> <p>TP4 FF25 25 Hz 3.8 Vp-p</p>	<p>W2</p> <p>IC3 (39) PIN CRYSTAL 1 32.768 kHz 3.3 Vp-p</p>
<p>W5</p> <p>TP3 CAPSTAN SAMPLE POSITION 25 Hz 4.9 Vp-p</p>	<p>W6</p> <p>IC3 (27) PIN CAPSTAN FG 500 Hz 4.3 Vp-p</p>
<p>W9</p> <p>TP13 SW-A PULSE 12.5 Hz 4.4 Vp-p</p>	<p>W10</p> <p>TP7 DRUM PULSE 37.5 Hz 0.9 Vp-p</p>
<p>W13</p> <p>IC3 (10) PIN DRUM TRAPE 12.5 Hz 5.0 Vp-p</p>	<p>W14</p> <p>TP5 DRUM SAMPLE POSITION 12.5 Hz 5.0 Vp-p</p>
<p>W17</p> <p>IC3 17 PIN TRACKING MMV 25 Hz 3.9 Vp-p</p>	<p>W18</p> <p>IC3 (18) PIN TRAP DUTY MMV 25 Hz 2.5 Vp-p</p>
<p>W21</p> <p>TP6 DRUM PHASE ERROR DC 2.5 V</p>	<p>W22</p> <p>IC301 (21) PIN SW REG OSC 40 kHz 2.0 Vp-p</p>
<p>W25</p> <p>TP102 CTL PULSE 25 Hz 1.2 Vp-p</p>	<p>W26</p> <p>TP103 DRUM PHASE ERROR DC 2.5 V</p>







Unless otherwise specified, all resistance values are in ohms, inductance values are in H, and capacitance values are in μF .
 MYP: Mylar capacitor
 NP: Non-polar capacitor
 P, PI: Polypropylene capacitor
 () parts are critical for safety. Replace only with specified numbers.

Hinweis:
 Bauteile in den schattierten Flächen sind Sicherheitsbauteile!
 Nur gegen Original-Ersatzteile auswechseln!

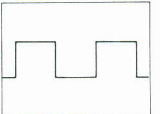
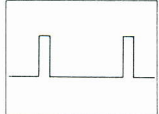
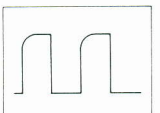
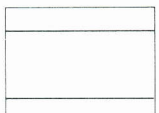
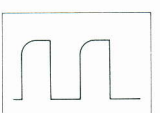
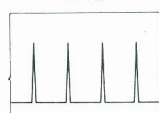
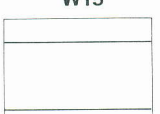
A digital transistor is a transistor that includes built-in resistors. NP and NPN transistors are available.

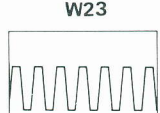
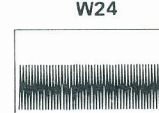

0 1 Platte Servo-Regelung / Mechaniksteuerung Mechacon / Servo PWB

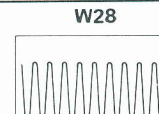
<p>W3</p>  <p>IC3 (37) PIN FF12.5 12.5 Hz 3.8 Vp-p</p>	<p>W4</p>  <p>IC3 (35) PIN V. PULSE 50 Hz 4.3 Vp-p duty (H) 180 μsec</p>
<p>W7</p>  <p>IC3 (22) PIN CAPSTAN MMV & PG 25 Hz 4.9 Vp-p</p>	<p>W8</p>  <p>TP2 CAPSTAN PHASE ERROR DC 2.5 V</p>
<p>W11</p>  <p>IC3 (7) PIN CH-1 SW MMV 37.5 Hz 4.9 Vp-p</p>	<p>W12</p>  <p>IC3 (9) PIN V. SYNC 50 Hz 0.9 Vp-p</p>
<p>W15</p>  <p>IC3 (12) PIN DRUM PHASE ERROR DC 2.5 V</p>	<p>W16</p>  <p>IC3 (13) PIN REC PHASE MMV 50 Hz 2.5 Vp-p</p>
<p>W19</p>  <p>IC3 (19) PIN CAPSTAN TRAPE -ZOID 30 Hz 4.9 Vp-p</p>	<p>W20</p>  <p>IC3 (21) PIN CAPSTAN PHASE ERROR DC 2.5 V</p>
<p>W23</p>  <p>IC103 (11) PIN CAPSTAN FG F/V IN 500 Hz 4.3 Vp-p</p>	<p>W24</p>  <p>TP101 CAPSTAN FG SCHMITT IN 500 Hz 2.1 Vp-p</p>
<p>W27</p>  <p>IC106 (11) PIN DRUM FG F/V IN 1500 Hz 4.2 Vp-p</p>	<p>W28</p>  <p>TP104 DRUM SCHMITT IN 1500 Hz 1.8 Vp-p</p>

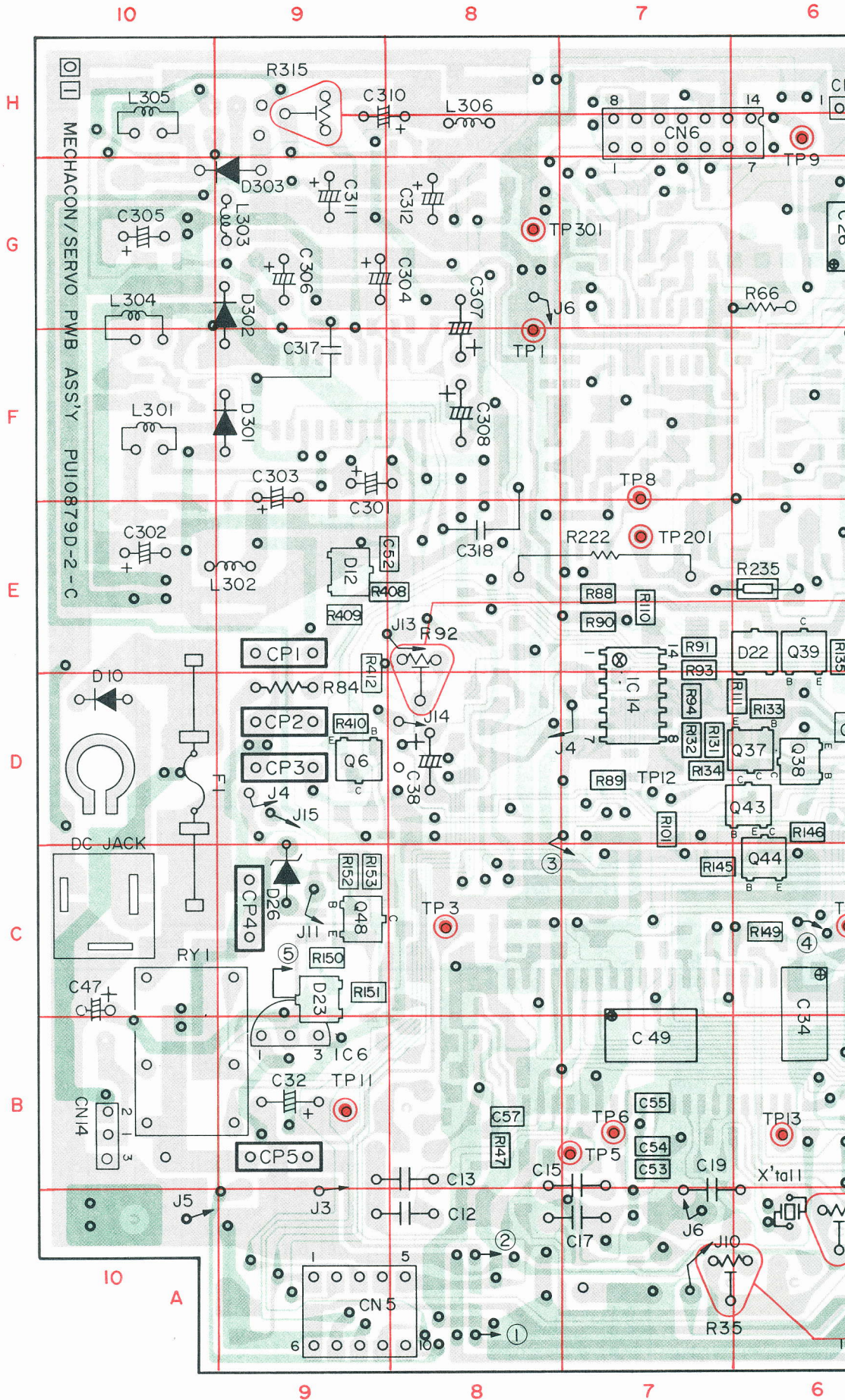

- Front -

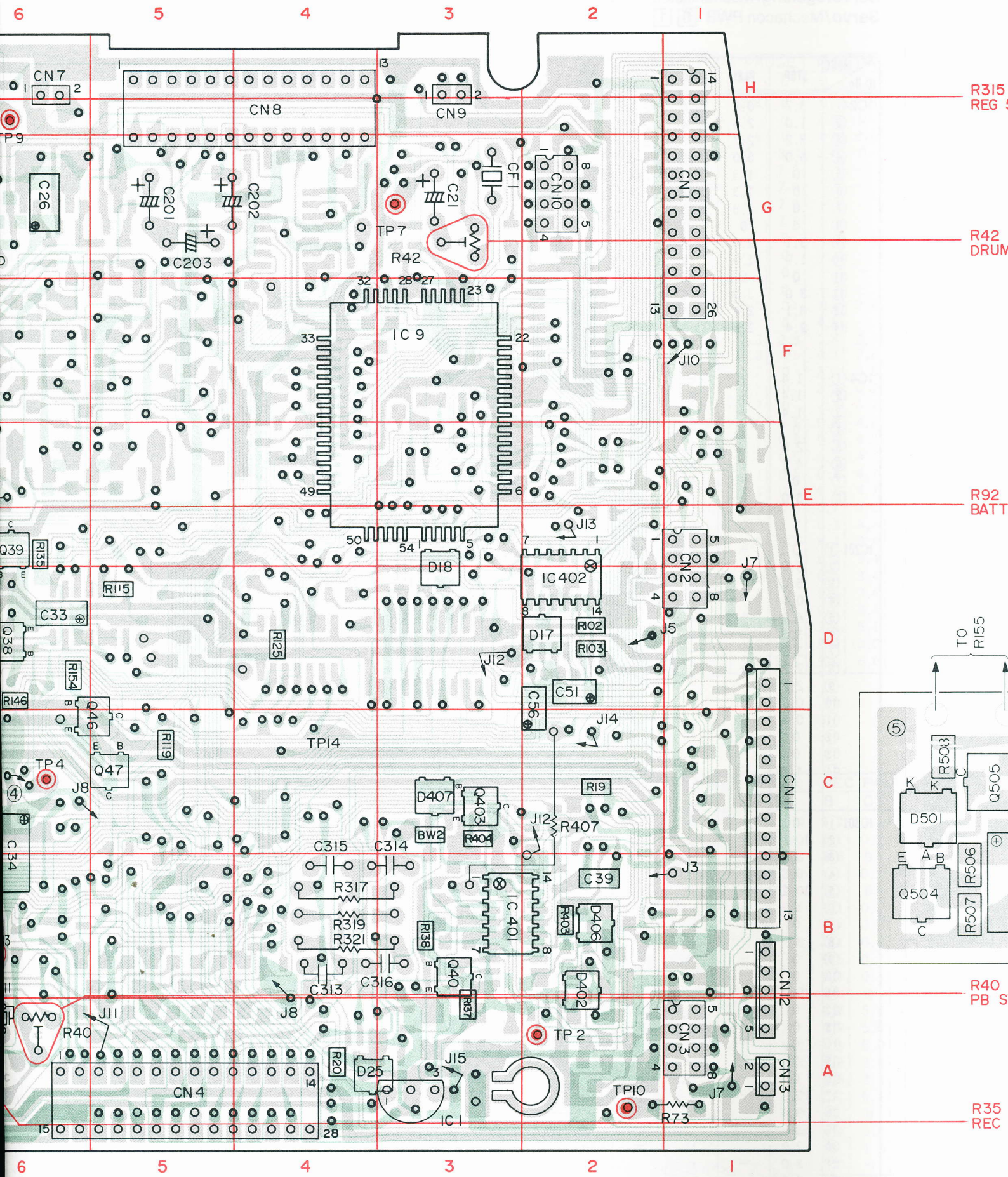

— Rear —

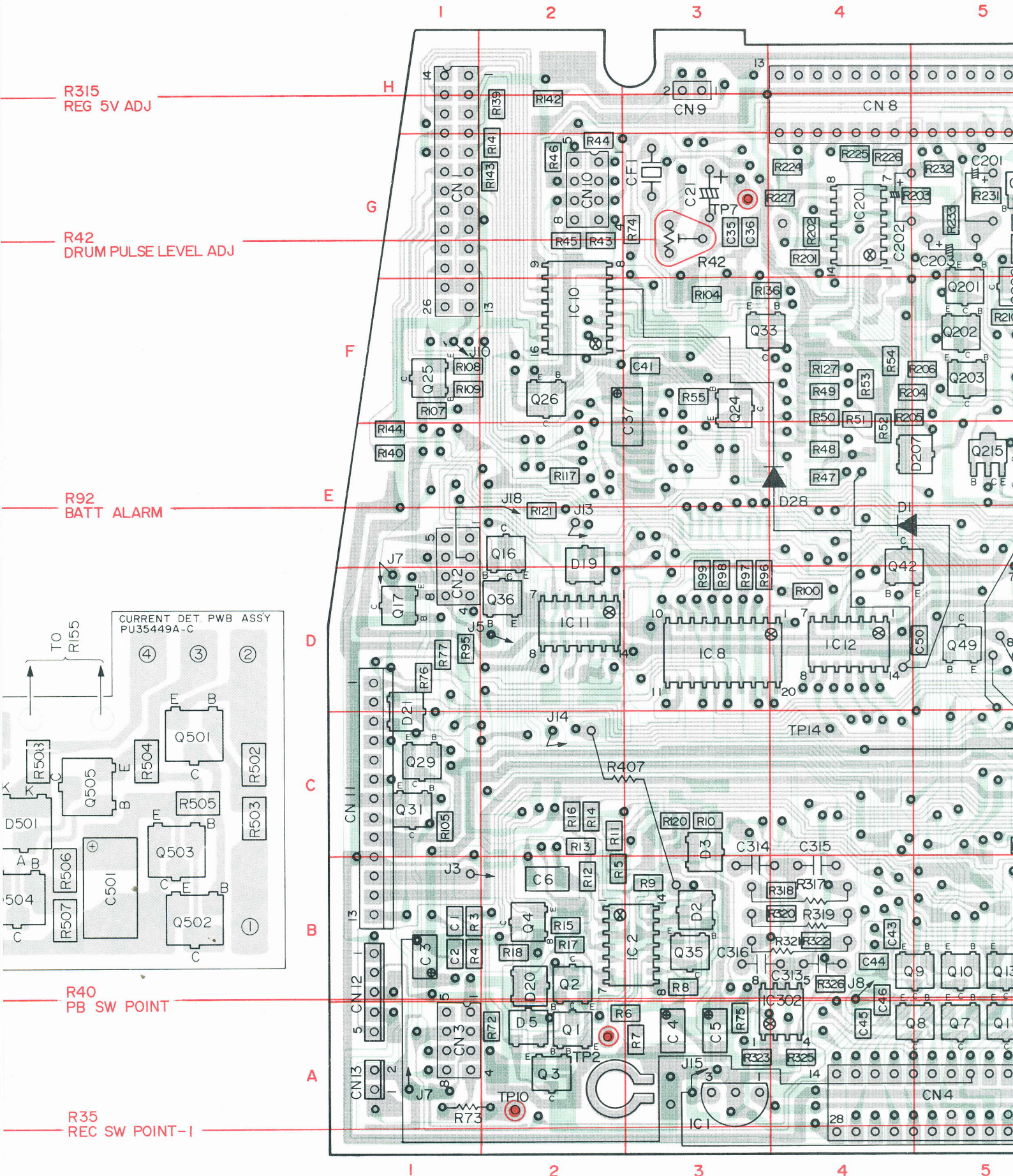

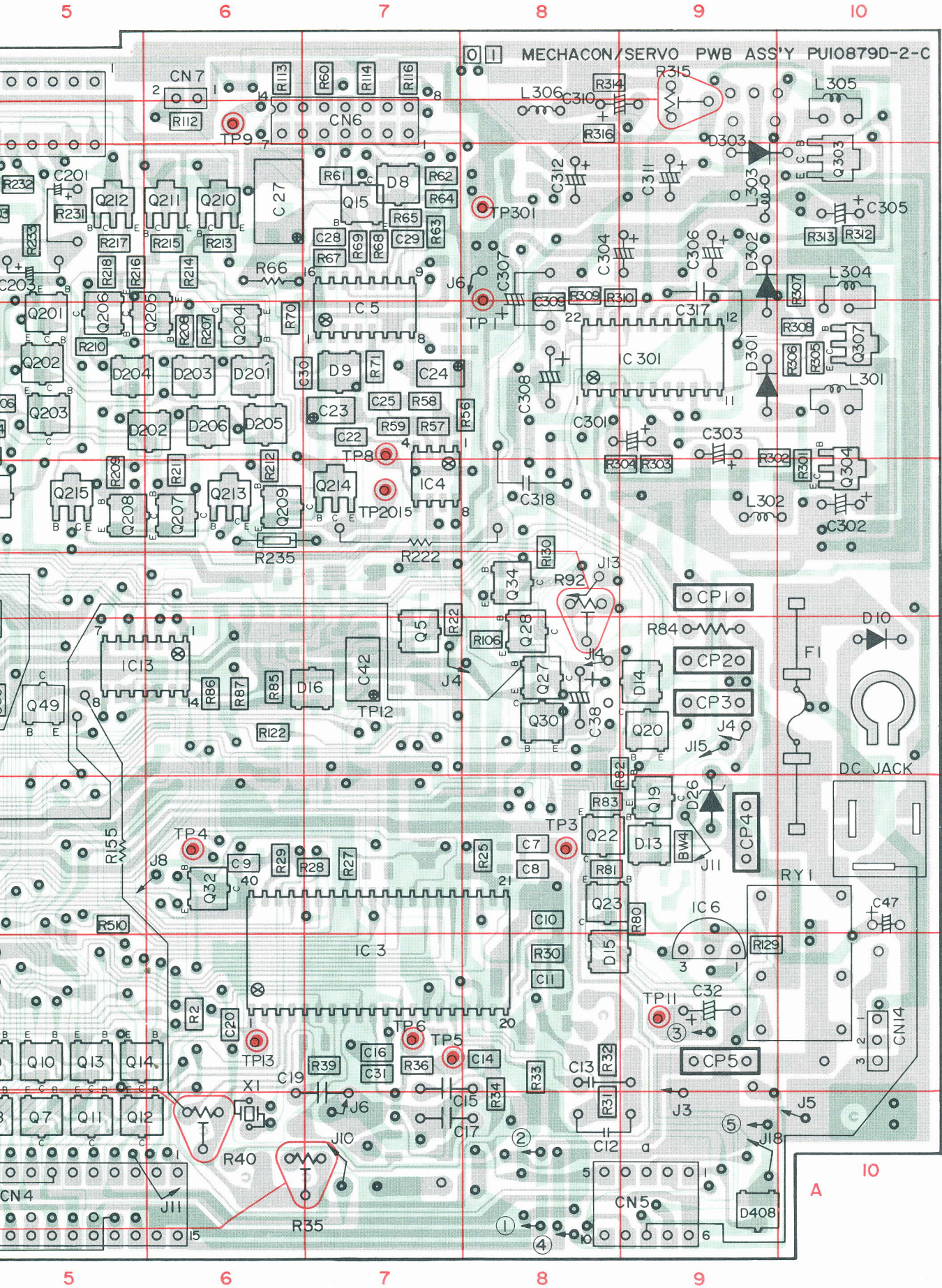

MODE	S
IC2-①	3
②	3
③	3
④	5
⑤	
⑥	
⑦	
⑧	
⑨	3
⑩	1
⑪	
⑫	3
⑬	3
⑭	2
IC4-①	
②	
③	
④	
⑤	
⑥	
⑦	
⑧	
IC201-①	
②	
③	
④	
⑤	
⑥	
⑦	
⑧	
⑨	
⑩	
⑪	
⑫	
⑬	
⑭	
IC301-①	
②	
③	
④	
⑤	
⑥	
⑦	
⑧	
⑨	
⑩	
⑪	
⑫	
⑬	
⑭	
⑮	
⑯	
⑰	
⑱	
⑲	
⑳	
㉑	
㉒	

0 1 Platte Servo-Regelung / Mechaniksteuerung (IC-Anschlüsse)
 Mechacon / Servo PWB (IC-Pin location)

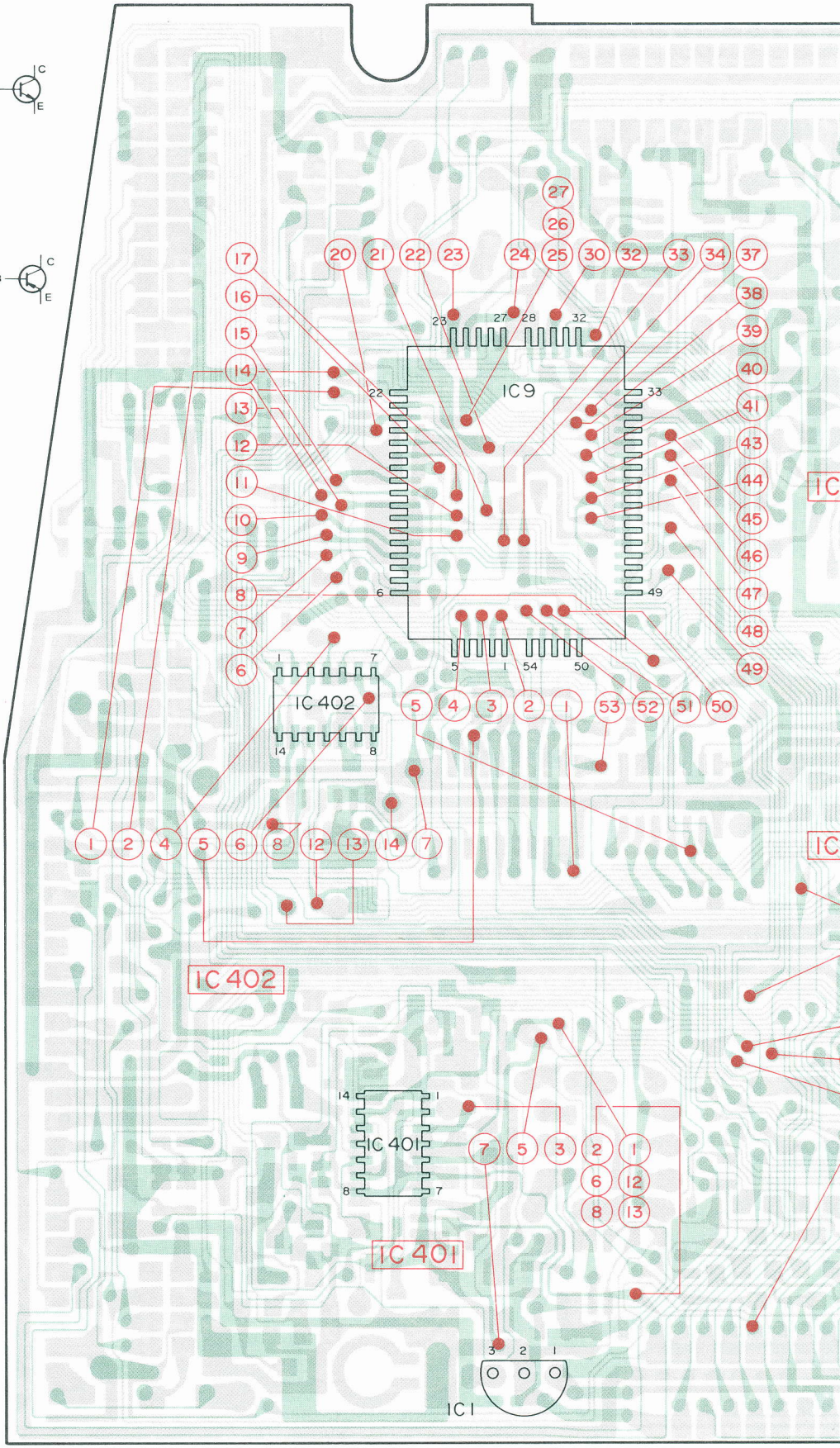
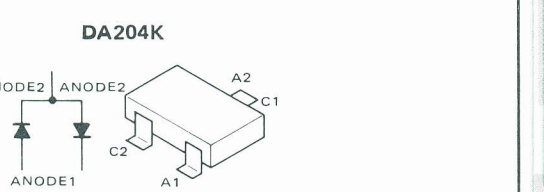
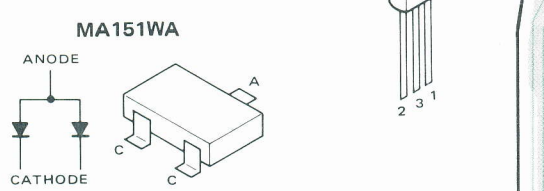
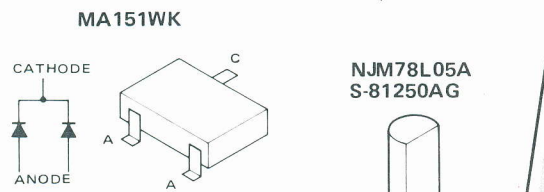
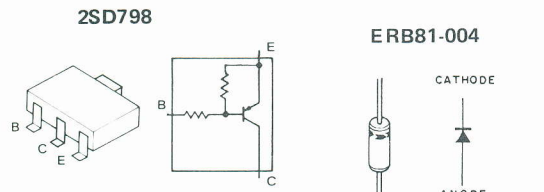
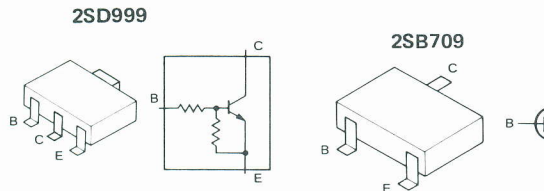
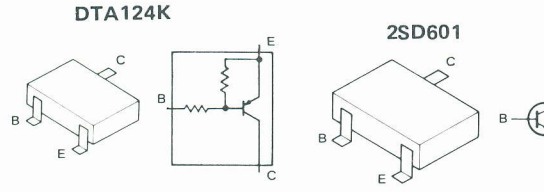
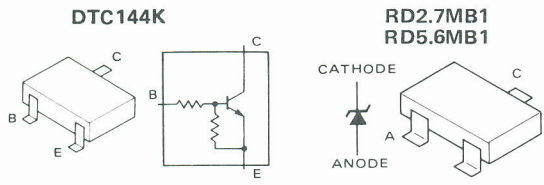

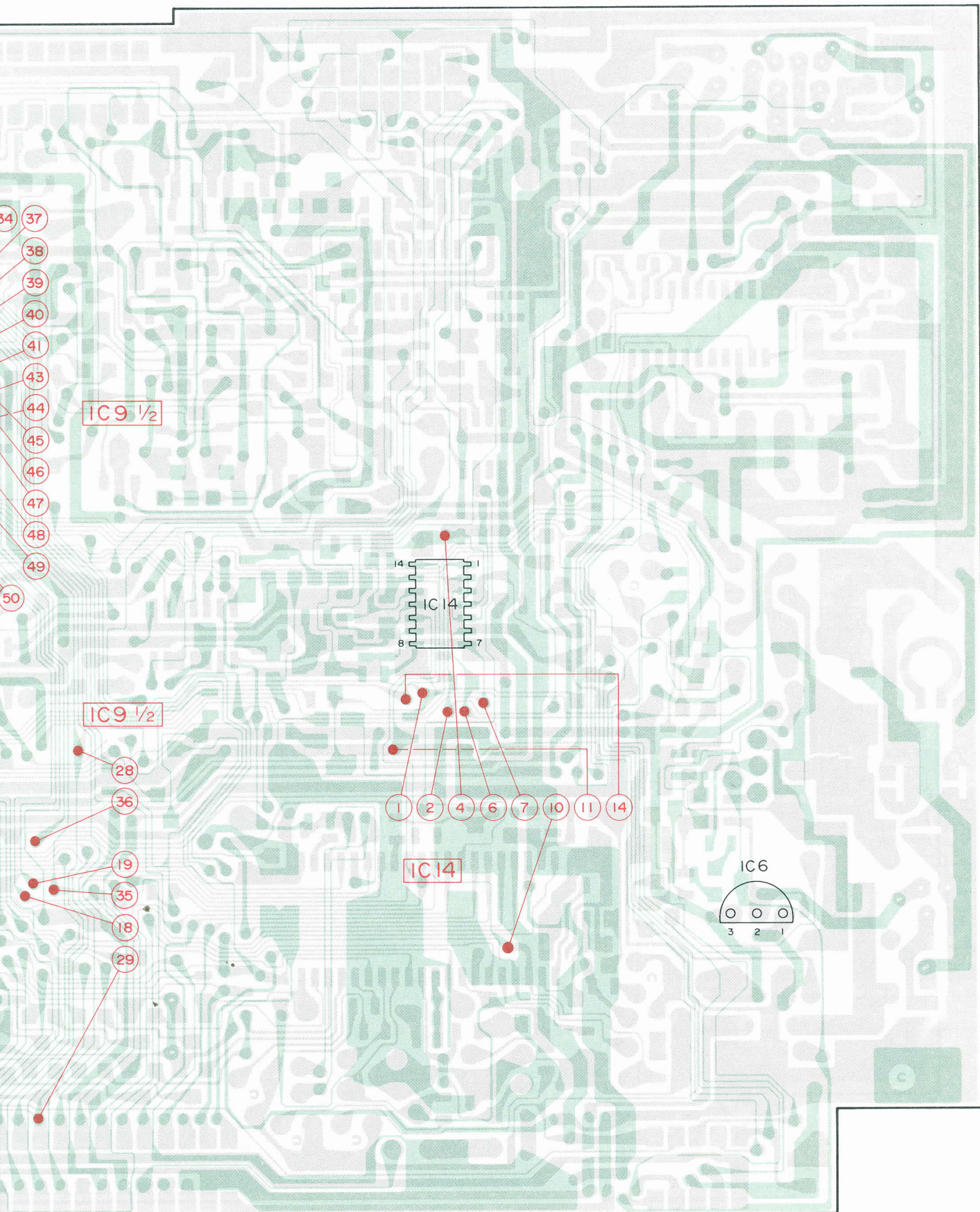

MODE	ST
IC2-①	3
②	1
③	3
④	5
⑤	
⑥	
⑦	
⑧	
⑨	3
⑩	1
⑪	
⑫	3
⑬	3
⑭	2
IC4-①	
②	
③	
④	
⑤	
⑥	
⑦	
⑧	
IC201-①	
②	
③	
④	
⑤	
⑥	
⑦	
⑧	
⑨	
⑩	
⑪	
⑫	
⑬	
⑭	
IC301-①	1
②	
③	
④	
⑤	1
⑥	
⑦	
⑧	
⑨	
⑩	1
⑪	
⑫	
⑬	
⑭	
⑮	
⑯	
⑰	
⑱	
⑳	
㉑	
㉒	

Audio/Servo-Platte 0 4
 Audio/Servo PWB 0 4

MODE IC No.	STOP	PLAY	REC	FWD. SEARCH	REV. SEARCH	PLAY PAUSE	REC PAUSE
IC101							
①	0.2	0.1	0.1	0.1	0.1	0.2	0.2
②	9.7	9.7	9.7	9.6	9.6	9.7	9.7
③	0	0	0	0	0.1	0.1	0.1
④	0.1	0.1	0	0.1	0	0	0
⑤	0.1	0	0	0	0.1	0.1	0.1
⑥	0	0	0	0.1	0.1	0	0
⑦	0	0.1	0	0	0.1	0	0.1
⑧	0	0	0	0.1	0	0	0
⑨	0.1	0	0	0	0	0	0.1
⑩	5.0	5.0	5.0	5.0	5.0	5.0	5.0
⑪	5.0	5.0	5.0	5.0	5.0	0	4.9
⑫	0	0	0	0.1	0	0.1	0.2
⑬	0	0	0.1	0.1	0.1	0	0.1
⑭	0	0	0.1	0	0	0	0
⑮	0.1	0.1	0.1	0.1	0.1	0.1	0
⑯	9.7	9.6	9.7	9.6	9.6	9.7	9.6
IC102-							
①	1.9	2.9	2.8	6.2	7.0	9.9	0
②	1.9	2.0	2.0	5.3	6.8	9.5	9.6
③	0	2.9	2.8	6.1	0.2	3.1	0
④	0.1	0.1	0	0.1	5.1	0.1	0.1
⑤	0	0	0	0.1	3.0	0	0
⑥	0	0	0	0	2.5	0	0
⑦	0.1	0.1	0.1	0	0.1	0.1	0.1
⑧	0.1	0	0.1	0	0	0	0
⑨	0	0.1	0.1	0	0.1	0	0
⑩	5.0	4.9	5.0	5.0	5.0	5.0	5.0
⑪	5.0	5.0	5.0	5.0	5.0	5.0	5.0
⑫	0	2.4	2.5	2.4	0.1	0	0
⑬	0.1	3.1	3.1	3.0	0.1	0	0
⑭	0.1	5.1	5.2	5.1	0.1	0	0.1
⑮	0	0.1	0.1	0.1	7.0	0.1	0
⑯	1.9	2.8	2.9	6.1	6.0	9.5	9.6
IC103-							
①	0.1	0	0	0.1	0	0	0
②	1.4	1.4	1.4	1.4	1.4	1.4	1.4
③	1.4	1.3	1.4	1.4	1.4	1.4	1.4
④	1.4	1.4	1.3	1.4	1.4	1.3	1.3
⑤	1.4	1.3	1.4	1.3	1.3	1.4	1.4
⑥	4.5	2.6	2.6	2.5	2.5	4.5	4.5
⑦	0.7	0.6	0.7	0.7	3.7	0.7	0.7
⑧	0	0	0.1	0	0.1	0.1	0
⑨	0.2	0.1	0.1	0.1	0	0.2	0.2
⑩	0	1.1	0.9	1.0	0.1	0.1	0
⑪	4.3	2.2	2.2	1.4	1.4	4.2	4.3
⑫	5.0	1.8	1.6	1.6	1.6	5.0	4.9
⑬	3.4	2.9	2.7	2.7	2.7	3.4	3.3
⑭	3.5	2.6	2.6	2.6	2.6	3.3	3.4
⑮	0.7	2.4	2.7	2.8	2.8	0.7	0.7
⑯	5.0	5.0	5.0	5.0	5.0	5.0	5.0
IC104-							
①	1.4	1.3	2.5	1.4	1.4	1.4	1.4
②	1.4	1.4	1.5	1.4	1.5	1.4	1.5
③	1.4	1.4	1.6	1.3	1.4	1.4	1.4
④	0	0	0.1	0.1	0.1	0.1	0
⑤	2.0	1.9	2.0	2.0	2.0	2.0	2.0
⑥	0.6	0.6	2.7	2.8	2.8	0.6	0.5
⑦	0	0	0	0	0	0	0
⑧	5.0	5.0	5.0	5.0	5.0	5.0	5.0

MODE IC No.	STOP	PLAY	REC	FWD. SEARCH	REV. SEARCH	PLAY PAUSE	REC PAUSE
IC105-							
①	3.9	2.3	2.4	2.4	2.3	2.3	2.6
②	0.7	2.5	2.5	2.6	2.5	2.5	2.5
③	1.7	2.5	2.5	2.6	2.4	2.5	2.6
④	5.0	5.0	5.0	5.0	5.0	5.0	5.0
⑤	0.4	0.4	0.4	0.4	0.4	0.4	0.3
⑥	0.4	0.3	0.3	0.3	0.3	0.3	0.3
⑦	0	0	0.1	0	0	0	0
⑧	0	0	0	0	0	0	0
⑨	3.3	2.5	2.6	2.6	2.5	2.5	2.6
⑩	1.7	1.7	1.7	1.6	1.7	1.7	1.7
⑪	0	0	0	0.1	0.1	0	0
⑫	3.4	3.3	3.3	3.3	3.4	3.3	3.3
⑬	3.4	2.6	2.7	2.6	2.4	2.5	2.6
⑭	3.2	3.9	3.9	3.9	3.8	3.9	3.9
IC106-							
①	0.1	0.1	0.1	0.1	0	0	0.1
②	1.4	1.4	1.4	1.4	1.4	1.3	1.4
③	1.5	1.4	1.5	1.4	1.4	1.5	1.4
④	1.4	1.4	1.4	1.4	1.4	1.4	1.4
⑤	1.4	1.4	1.4	1.4	1.4	1.4	1.4
⑥	4.3	2.3	2.3	2.2	2.3	2.2	2.2
⑦	0.7	0.6	0.7	0.7	3.7	0.6	0.7
⑧	0.1	0	0.1	0	0	0	0
⑨	0.1	0.1	0.1	0.1	0.1	0.2	0.2
⑩	0.1	0.2	0.2	0.2	0.0	0.2	0.2
⑪	4.2	2.2	2.2	2.2	2.2	2.2	2.2
⑫	5.0	1.6	1.6	1.5	1.6	1.6	1.5
⑬	3.4	2.7	2.8	2.7	2.8	2.7	2.8
⑭	3.6	2.6	2.6	2.6	2.6	2.6	2.6
⑮	0.7	2.5	2.6	2.6	2.4	2.5	2.5
⑯	5.0	5.0	5.0	5.0	5.0	5.0	5.0

Spannungstabellen · DC voltage tables

Servoregelung / Mechaniksteuerung Platte **0 1**

Servo / Mechacon PWB **0 1**

MODE IC No.	STOP	PLAY	REC	FWD. SEARCH	REV. SEARCH	PLAY PAUSE	REC PAUSE
IC1-①	10.1	10.2	10.2	10.1	10.1	10.2	0.2
②	0	0	0	0	0	0.1	0.1
③	4.9	5.0	5.0	5.0	5.0	5.0	5.0
IC5-①	0	0	0	0	0	0	0
②	0	0	0	0	0	0	0.1
③	0	0	0	0	0	0	0.1
④	0.1	0	0	0	0	0	0
⑤	5.0	0	0	0	0	0	0
⑥	0	0	0.1	0	0	0.1	0
⑦	0.1	0	0	0	0	0	0
⑧	5.0	4.9	5.0	5.0	5.0	5.0	5.0
⑨	5.1	4.9	5.0	5.0	5.0	5.0	5.0
⑩	0	0	0.1	0	0	0.1	0
⑪	0.2	0.2	0.3	0.3	0.2	0.2	0.2
⑫	5.0	4.9	4.9	4.9	4.9	4.9	4.9
⑬	0	0	0	0	0	0.1	0.1
⑭	0	1.3	1.4	1.3	1.3	1.3	1.3
⑮	0	2.3	2.4	2.4	2.5	2.4	2.5
⑯	5.0	5.0	5.0	5.0	5.0	5.0	5.1
IC6-①	0	0	0	0	0	0	0.1
②	10.1	10.1	10.0	9.9	9.9	10.0	9.9
③	5.2	0	5.2	0	0	5.1	5.1
IC8-①	5.1	5.1	5.1	5.0	5.1	5.0	5.1
②	5.0	5.0	5.0	5.0	5.0	4.9	4.7
③	5.1	5.2	5.1	5.0	5.0	5.1	5.1
④	0	4.9	5.0	5.0	0	5.0	5.0
⑤	5.1	5.1	5.1	5.0	5.0	5.1	5.1
⑥	5.1	5.0	0	0	0	0.1	0
⑦	5.1	1.1	5.0	5.0	5.0	5.0	5.1
⑧	4.9	0.1	0	0.1	0	0	0
⑨	5.0	5.0	5.0	5.0	5.0	5.0	5.0
⑩	0	0	0	0	0.1	0.1	0
⑪	0	0	0	0	0	0	0
⑫	5.1	5.0	4.9	5.0	5.0	5.0	4.9
⑬	0	0	0	0	0	0	0
⑭	5.1	5.0	5.0	5.0	5.0	5.0	5.1
⑮	5.0	0	0.1	0	0	0	0
⑯	5.0	5.1	5.1	5.0	5.0	5.0	5.1
⑰	5.1	5.0	0	0	0.1	0	5.0
⑱	5.1	5.1	5.0	5.1	5.0	5.1	5.1
⑲	5.1	5.1	5.1	5.1	5.1	5.1	5.1
⑳	5.1	5.1	5.1	5.1	5.0	5.1	5.1
IC9-①	5.1	5.1	5.1	5.0	5.1	5.1	5.1
②	5.1	5.1	0.1	5.1	5.1	5.1	5.1
③	5.1	0.1	0	5.1	5.1	5.1	5.1
④	0.1	5.1	0	5.1	5.1	5.1	0.1
⑤	5.1	5.1	0	5.1	5.0	5.0	0.1
⑥	5.1	5.1	5.2	5.1	5.1	5.1	5.1
⑦	4.9	2.4	0.1	0.6	4.9	0	0
⑧	5.2	0.1	1.3	5.1	1.6	0.1	0
⑨	3.3	0.1	0.1	0.1	0	0	0.1
⑩	3.3	3.3	3.3	3.3	0.1	3.3	3.3
⑪	5.1	5.1	5.1	5.1	5.1	5.1	0
⑫	5.1	5.2	5.1	5.1	5.0	5.1	0
⑬	5.0	5.0	4.9	4.9	4.9	4.9	0
⑭	5.1	5.0	5.0	5.1	5.0	5.0	0

MODE IC No.	STOP	PLAY	REC	FWD. SEARCH	REV. SEARCH	PLAY PAUSE	REC PAUSE
IC9-⑮	5.1	5.1	5.1	5.0	5.0	5.1	0
⑯	5.1	5.1	5.1	5.0	5.1	5.1	0
⑰	5.1	0	0	0	0	0.1	0
⑱	0	5.1	5.1	5.1	0	0.1	0
⑲	0	0	0.1	0.1	5.0	0.1	0
⑳	5.1	0	0	0.1	0	0.1	0
㉑	0	0	0.1	0	0	0	0
㉒	0	0	0	0.1	0	0.1	0
㉓	2.7	2.7	2.7	2.7	2.7	2.7	0
㉔	2.8	2.9	2.8	2.8	2.8	2.8	0
㉕	5.2	5.1	5.2	5.1	5.0	5.1	0
㉖	5.2	5.2	5.2	5.1	5.1	5.1	0
㉗	5.1	5.1	5.1	5.2	5.1	5.1	0
㉘	0.1	0.1	0.1	0	0.1	0	0
㉙	0.1	0	0.1	0	0	0.1	0
㉚	5.0	4.9	0.1	4.9	5.0	5.0	0.1
㉛	5.1	5.1	0.1	5.1	5.0	5.1	0.1
㉜	0.1	0.1	0.1	5.0	5.1	5.0	0
㉝	5.1	5.1	0.1	5.1	5.1	5.1	0
㉞	5.1	0.1	5.1	0.1	0.1	0	0
㉟	0.1	0.2	0.1	5.1	5.1	0.1	0
㊱	0	2.6	2.6	2.5	2.5	0.1	0
㊲	0	2.6	2.5	2.6	2.5	2.5	0
㊳	5.1	5.0	5.1	0	5.1	5.1	0
㊴	5.1	5.1	5.1	5.0	0	0	0
㊵	0.1	5.0	5.1	5.1	5.0	0	0
㊶	5.0	5.1	0	5.0	5.1	0	0
㊷	5.1	5.0	5.1	5.1	5.1	0	0.2
㊸	5.1	5.0	5.1	5.0	5.1	0	0
㊹	5.1	0	0	0.1	0.1	0	0
㊺	0.6	0.6	0.6	0.6	0.6	0.6	0.6
㊻	0	0	0.1	0	0	0	0
㊼	0.1	0	0	0	0	0	0
㊽	0.1	5.0	5.0	0.1	0.1	0	0
㊾	0.1	0	0.1	5.0	5.0	0	0
㊿	5.1	5.1	5.1	5.1	5.0	0	0
①	5.1	5.1	5.1	5.0	5.1	0	0
②	5.1	5.1	5.1	5.0	5.1	0	0
③	5.0	5.1	5.1	0	0	0	0
④	0	0	0.1	0	0.1	0	0.1
⑤	5.0	5.0	5.0	5.0	5.0	5.0	5.0
⑥	7.5	5.0	0	5.2	5.1	5.0	7.6
⑦	0.6	3.9	1.3	0.1	0.7	3.8	0.6
⑧	0.6	3.8	0.7	0.7	0	3.8	0.6
⑨	0.1	3.9	0.7	0.6	0.7	3.9	0.6
⑩	0.6	3.8	0	0.6	0.7	3.9	0
⑪	3.9	3.9	3.8	3.8	3.9	0.1	0
⑫	3.8	0.1	0.1	0	0	0.0	0.1

IC10-

①	5.0	0	0	0	0	0.1	0
②	5.0	5.1	5.0	5.1	5.1	0	0
③	5.1	5.0	0	5.0	5.1	5.0	0
④	0.1	5.0	5.0	5.0	5.0	5.1	5.1
⑤	5.1	5.1	5.0	5.1	0	5.0	5.1
⑥	5.1	5.1	5.0	0	5.0	5.1	5.1
⑦	5.0	5.0	0	4.9	5.0	5.0	5.0
⑧	0	0	0.1	0	0.1	0	0.1
⑨	5.0	5.0	5.0	5.0	5.0	5.0	5.0
⑩	7.5	5.0	0	5.2	5.1	5.0	7.6
⑪	0.6	3.9	1.3	0.1	0.7	3.8	0.6
⑫	0.6	3.8	0.7	0.7	0	3.8	0.6
⑬	0.1	3.9	0.7	0.6	0.7	3.9	0.6
⑭	0.6	3.8	0	0.6	0.7	3.9	0
⑮	3.9	3.9	3.8	3.8	3.9	0.1	0
⑯	3.8	0.1	0.1	0	0	0.0	0.1

Servoregelung/Mechaniksteuerung Platte **0 1**
 Servo/Mechacon PWB **0 1**

MODE IC No.	STOP	PLAY	REC	FWD. SEARCH	REV. SEARCH	PLAY PAUSE	REC PAUSE
IC11-							
①	5.1	5.1	5.1	5.1	5.1	5.1	5.1
②	0	0	0	0	0	0.1	0.1
③	5.2	5.1	5.0	5.1	5.1	5.1	5.1
④	5.1	5.1	5.1	5.0	5.1	5.1	5.1
⑤	0	0	0	0	0.1	0	0
⑥	5.1	5.1	5.0	5.1	5.1	5.1	5.1
⑦	0.1	0	0.1	0	0	0.1	0.1
⑧	5.1	5.1	5.1	5.0	5.0	5.1	5.1
⑨	5.1	5.1	5.2	5.1	5.1	5.1	5.2
⑩	5.1	5.1	5.1	5.1	5.1	5.1	5.1
⑪	0	0	0	0.1	0	0	0
⑫	0.1	0.1	0.1	0	0	0	0.1
⑬	0	0.1	0	0	0.1	0	0
⑭	5.1	5.1	5.2	5.1	5.1	5.1	5.1
IC12-							
①	5.1	0	0	5.1	5.1	5.1	5.2
②	5.0	5.0	0.1	5.0	5.0	5.0	5.0
③	0	5.1	5.1	0.1	0	0.1	0.1
④	0.1	0	0.1	0	0.1	0	0.1
⑤	5.1	5.1	5.1	5.1	5.1	5.1	5.1
⑥	5.2	5.2	5.1	5.1	5.0	5.1	5.1
⑦	0	0	0	0	0	0.1	0.1
⑧	2.6	0.9	0.1	0.6	0.7	3.8	0.1
⑨	0	0	0	0	0	0	0.1
⑩	5.1	5.1	5.2	5.2	5.2	5.2	5.1
⑪	0	5.1	5.1	5.1	5.1	5.1	5.1
⑫	5.1	5.1	0.1	5.1	5.1	5.1	0.1
⑬	5.1	0	5.1	0.1	0.1	0	5.1
⑭	5.1	5.2	5.1	5.1	5.1	5.1	5.1
IC13-							
①	5.1	5.1	0	5.1	5.1	5.1	5.1
②	0	0	5.1	0	0.1	0	0
③	0.9	4.1	0.9	3.6	3.5	2.2	0.8
④	0.4	0.1	1.7	0.1	1.4	4.8	5.1
⑤	1.3	1.2	1.2	3.3	1.3	4.5	4.6
⑥	0.3	0	0.1	1.6	4.9	0.1	0
⑦	0.1	0	0	0	0	0	0
⑧	0	0.1	0.1	0	0.1	0	0
⑨	5.1	5.1	5.1	5.1	5.1	5.1	5.2
⑩	5.1	5.2	5.1	5.1	5.1	5.1	5.1
⑪	0.1	0	0	0.1	0	0	0
⑫	0.1	0	0	0	0	0	0.1
⑬	4.9	4.9	4.9	4.9	4.9	4.9	4.9
⑭	5.2	5.2	5.1	5.1	5.1	5.1	5.2
IC14-							
①	0	0	0	0	0	0	0
②	3.0	3.0	3.0	3.0	3.0	0.1	3.0
③	2.5	2.5	2.5	2.5	2.5	0	2.5
④	5.0	5.0	5.0	5.0	5.0	0	5.0
⑤	2.5	2.5	2.6	2.5	2.5	0	2.5
⑥	2.9	2.9	2.9	2.9	2.8	0	2.9
⑦	0	0	0	0	0	0	0
⑧	0.7	0.7	0.7	0.8	0.7	0	0
⑨	1.4	1.4	1.4	1.5	1.4	0	0
⑩	0.6	0.6	0.6	0.6	0.6	0	0.6
⑪	0	0	0	0	0	0	0
⑫	0.1	0.1	0.1	0.1	0.1	0	0.1
⑬	2.5	2.5	2.5	2.5	2.4	0.1	2.5
⑭	0	0	0.1	0	0	0	0

MODE IC No.	STOP	PLAY	REC	FWD. SEARCH	REV. SEARCH	PLAY PAUSE	REC PAUSE
IC401-							
①	4.9	0	0	0	0.1	0	0
②	0.1	0.1	0	0	0	0	0
③	5.0	5.0	5.0	4.9	4.9	0	0
④	5.0	5.0	5.0	5.0	4.9	0	0.1
⑤	0.1	0	0.1	0	0.1	0	0
⑥	0.1	5.0	5.1	5.0	4.9	0	0
⑦	0	0	0.1	0.1	0	0	0
⑧	5.0	0.1	0	0	0	0	0
⑨	5.0	0	0.1	0	0.1	0	0
⑩	0.1	5.0	5.0	0	4.9	0	0
⑪	5.0	5.0	5.0	5.0	5.0	0	0
⑫	0	0	0	0.1	0	0	0
⑬	0	0	0	5.0	0	0	0
⑭	5.0	5.0	5.0	5.0	5.0	0	0
IC402-							
①	4.8	4.8	4.8	0	4.8	0	0
②	4.8	4.8	—	4.8	4.8	4.8	0
③	4.9	4.9	4.9	4.9	4.9	4.9	0
④	0	0	0	0	0	0	0
⑤	0	0	0	0	0	0	0
⑥	0	0	0	0	0	0	0
⑦	0	0	0	0	0	0	0
⑧	4.9	4.9	4.9	4.9	4.9	4.9	4.9
⑨	4.9	4.9	4.9	4.9	4.9	4.9	0
⑩	4.9	4.9	4.9	4.9	4.9	4.9	4.9
⑪	4.9	4.9	4.9	4.9	4.9	4.9	4.9
⑫	5.0	5.0	5.0	5.0	5.0	5.0	5.0
⑬	4.8	0	4.8	4.8	4.8	4.8	0
⑭	4.9	4.9	4.9	4.9	4.9	4.9	4.9

Spannungstabellen · DC voltage tables

Servoregelung/Mechaniksteuerung Platte **0 1**

Servo/Mechacon PWB **0 1**

TR No.	MODE			STOP			PLAY			REC			FWD. SEARCH			REV. SEARCH			PLAY PAUSE			REC PAUSE		
	B	C	E	B	C	E	B	C	E	B	C	E	B	C	E	B	C	E	B	C	E	B	C	E
Q 5	0	4.6	0	5.1	0.1	0.1	0	4.6	0	5.1	0.1	0	5.1	0	0	5.1	0.1	0	0.1	4.6	0.1			
Q15	5.0	0	5.1	5.0	0.1	5.0	5.0	0.2	5.0	4.9	0.1	5.0	5.0	0.1	4.9	5.0	0.1	5.0	5.0	0.2	5.0			
Q16	5.1	0.1	0	0.1	4.6	0	5.1	0	0	0	4.6	0	0	4.6	0	0	4.5	0	5.1	0.1	0			
Q19	10.2	0	10.1	10.1	0.1	10.2	10.1	0	10.2	10.1	0.1	10.1	10.1	0	10.1	10.1	0	10.1	10.2	0	10.1			
Q20	5.2	0	5.2	5.1	0.1	5.2	5.1	0	5.1	5.1	0	5.1	5.1	0.1	5.1	5.1	0.1	5.1	5.1	0.1	5.1			
Q22	0	10.2	0	0	10.2	0	0	10.1	0	0	10.1	0	0	10.1	0	0	10.2	0	0	10.2	0			
Q23	0.1	10.2	0	0	10.1	0.1	0.1	10.2	0	0	10.1	0	0	10.1	0	0	10.2	0	0	10.1	0			
Q24	3.7	0.1	0.1	0.1	2.5	0	0	2.5	0	1.2	10.1	0	5.1	3.8	0.1	0	2.5	0.1	0	2.9	0			
Q25	3.9	5.1	3.3	3.8	5.2	3.3	3.9	5.1	3.4	3.9	5.2	3.4	3.9	5.1	3.3	3.8	5.2	3.4	3.9	5.1	3.4			
Q26	5.0	0.1	0	5.0	0	0	0.1	3.3	0	5.0	0.1	0	5.0	0	0	5.0	0.1	0	5.0	0.1	0			
Q27	4.7	0	0	0.1	7.1	0	4.6	0.1	0	0	7.1	0	0.1	7.1	0	0	7.0	0	4.6	0.1	0			
Q28	0	5.0	0	0.1	4.9	0	3.7	0	0	0	5.0	0	0.1	5.0	0	0.1	5.0	0.1	0.1	5.0	0.1			
Q29	0	2.0	0	5.1	0	0	5.1	0	0	5.1	0	0	5.1	0	0.1	5.1	0.1	0	5.1	0.1	0			
Q30	0.1	2.7	0	3.6	0	0	3.6	0	0	3.5	0.1	0.1	3.5	0	0	3.6	0	0	3.6	0	0			
Q31	5.1	0	0	5.1	0	0.1	0	0.1	0	5.1	0	0	5.1	0	0	5.1	0	0	0	0.1	0			
Q33	0	5.1	0	2.1	2.5	0	2.1	2.6	0	2.1	0.5	0	2.0	2.6	0	2.1	2.5	0	2.1	2.6	0			
Q34	5.0	0	0	5.0	0	0	5.0	0	0	5.0	0	0	5.0	0	0	5.0	0	0	5.0	0	0			
Q36	0	5.0	0	4.5	0.1	0	0.1	5.0	0	4.6	0.1	0.1	4.6	0.1	0.1	4.6	0	0.1	0	5.1	0			
Q37	0	0.1	0.1	4.1	0	0	4.2	0	0	4.2	0	0	4.2	0	0	4.2	0	0	4.2	0	0			
Q38	0	4.2	0	0.1	0.1	0	0.1	4.2	0	0.1	4.2	0.1	0	4.2	0.1	0	4.2	0	0	4.2	0.1			
Q39	0.1	0	0	0	1.6	0	0.1	1.5	0	0	1.6	0	0	1.5	0	0	1.5	0.1	0.1	1.6	0.1			
Q40	0.5	0	0	0.1	2.5	0	0	2.6	0	0.1	2.5	0	0	2.5	0.1	0.1	2.5	0	0	2.9	0.1			
Q41	5.1	3.8	0	5.1	3.8	0	0	2.1	0	5.1	3.8	0	0	2.5	0	5.1	3.8	0.1	5.1	3.8	0			
Q42	0	10.2	0	0.1	10.1	0	0	10.1	0	0.1	2.5	0	0	10.1	0	0	10.1	0	0	10.2	0			

Servoregelung/Mechaniksteuerung Platte **0 1** (Steckeranschlüsse)

Servo/Mechacon PWB **0 1** (Connectors)

MODE CN No.	STOP	PLAY	REC	FWD. SEARCH	REV. SEARCH	PLAY PAUSE	REC PAUSE
CN1-①	3.8	3.8	3.8	3.8	3.9	0	0.1
②	3.8	0.1	0.1	0	0.1	0	0
③	0.6	3.9	0	0.7	0.7	3.9	0.1
④	5.1	5.1	5.1	5.1	5.1	5.1	5.1
⑤	5.1	5.1	5.0	5.0	5.1	5.0	4.9
⑥	5.1	5.2	5.1	5.1	5.1	5.1	5.1
⑦	0.1	2.5	0.1	0	4.2	4.9	4.9
⑧	0.1	0	0	0.1	0	0	0.1
⑨	0	0	0	0	0	0.1	0.1
⑩	5.0	5.0	5.0	0.1	5.0	5.0	5.0
⑪	0	0	0.1	0.1	0.1	0	0
⑫	0	0.1	0	0	0	0	0
⑬	0	0	3.3	0	0.1	0	0
⑭	0.1	3.8	3.9	0.6	0.7	3.8	0.6
⑮	0.6	3.8	0.7	0.7	0	3.9	0.6
⑯	0.6	3.8	0.7	0	0.7	3.9	0.6
⑰	5.1	5.1	5.1	5.1	5.1	5.1	5.1
⑱	5.1	5.2	5.1	5.0	5.1	5.1	5.2
⑲	5.0	5.1	5.1	5.0	5.1	5.1	5.1
⑳	5.1	5.1	5.1	5.1	5.2	5.2	5.1
㉑	3.4	3.4	3.4	3.2	3.4	3.3	3.4
㉒	3.3	0.1	0.1	0.1	0.1	0	0.1
㉓	3.4	0	3.3	3.3	0	3.3	0
㉔	0	0.1	0.1	0	0	0	0
㉕	0	0	0	0	0	0	0
㉖	0	0.1	0	0	0.1	0.1	0

MODE CN No.	STOP	PLAY	REC	FWD. SEARCH	REV. SEARCH	PLAY PAUSE	REC PAUSE
CN2-①	4.0	3.9	2.6	4.0	4.0	3.9	4.0
②	0.1	4.6	0.1	4.6	4.5	4.6	0
③	5.0	0.1	5.0	0.1	0.1	0.1	5.0
④	5.1	5.0	5.0	5.0	5.0	5.0	5.0
⑤	3.0	2.7	2.7	2.6	2.6	2.6	2.8
⑥	0.4	0.4	0.4	0.4	0.4	0.4	0.4
⑦	6.7	6.7	6.4	6.6	6.7	6.3	6.7
⑧	0.0	0	0.1	0.1	0	0.1	0
CN3-①	3.1	0	0.1	0.1	0.1	0	0
②	2.0	0	0.1	0	0	0.1	0
③	4.2	0.1	0	5.1	5.1	5.0	0.1
④	0	5.0	5.0	5.0	5.0	5.0	5.0
⑤	3.1	4.0	3.8	4.0	4.1	3.9	4.0
⑥	2.0	0	0.1	0.1	0	0	0.1
⑦	4.2	2.2	2.1	2.1	2.1	2.1	2.1
⑧	0	0	0.1	0	0	0.1	0.1

Servoregelung/Mechaniksteuerung Platte 0 1 (Steckeranschlüsse)

Servo/Mechacon PWB 0 1 (Connectors)

MODE CN NO.	STOP	PLAY	REC	FWD. SEARCH	REV. SEARCH	PLAY PAUSE	REC PAUSE
CN4-①	0.6	2.5	2.4	2.6	2.4	2.5	2.5
②	0.5	2.8	2.8	2.7	2.8	4.6	4.5
③	0	0	0	0	0	0.1	0
④	4.8	2.6	2.6	2.6	2.6	4.7	4.7
⑤	4.2	2.3	2.3	1.4	1.4	4.3	4.3
⑥	0.1	0.1	0.1	0.1	5.1	0.1	0
⑦	0.1	0.1	0.1	5.1	5.1	0.1	0.1
⑧	0.1	5.2	5.2	5.1	0.1	0	0.1
⑨	5.0	0	0	0.1	0	0	0
⑩	0.1	0.1	0.1	0	0	0	0.1
⑪	3.9	2.3	2.3	2.4	2.4	2.3	2.6
⑫	0.7	2.7	2.7	2.8	2.9	0.7	0.8
⑬	0	0.1	0	0	0.1	0.1	0.1
⑭	0.1	2.1	2.1	2.1	2.2	2.1	2.1
⑮	0.1	0.1	0	0	0	0.1	0
⑯	10.2	10.1	10.1	10.1	10.1	10.1	10.2
⑰	0	0	0	0	0.1	0	0.1
⑱	5.0	5.0	5.0	5.0	5.0	5.0	5.0
⑲	0.1	0	0	0.1	0	0	0
⑳	1.8	2.8	2.8	5.9	6.9	10.0	10.0
㉑	0	0.1	0.1	0	0	0	0
㉒	0	0.1	0	0	0.1	0.1	0
㉓	4.9	0	0	0.1	0	0.1	0
㉔	0.1	0	5.0	5.0	0	5.0	5.0
㉕	0.1	0.1	0	0	0	0.1	0.1
㉖	1.0	0.9	2.4	0.9	1.0	1.0	1.0
㉗	3.0	3.1	2.3	2.1	2.4	2.2	2.3
㉘	0	0	0.1	0	0.1	0.1	0
CN5-①	0.1	4.2	0.1	4.1	4.1	4.1	0
②	0	0.1	5.1	0.1	0	0	0
③	0.1	5.1	5.1	0	0.1	0.1	0.1
④	0	0.1	0	0	0	0.1	0
⑤	5.0	5.0	5.0	5.0	5.0	5.0	5.0
⑥	6.5	6.7	6.4	6.7	6.7	6.4	6.6
⑦	0.3	0.9	0.3	0.7	0.8	0.2	0.2
⑧	0.1	0	0	0	0	0	0.1
⑨	5.0	0.1	0	0.1	0	0	0
⑩	0.1	2.3	2.4	2.3	2.3	2.3	2.3
CN6-①	0.2	0.2	0.2	0.1	0.1	0.1	0.2
②	0	0.1	0	0	0	0	0
③	0	0	0	0.1	0.1	0	0
④	0	0	0.1	0.1	0	0	0.1
⑤	0.1	0.1	0.1	0.1	0.1	0.1	0.1
⑥	0.2	0.5	0.3	0.7	0.8	0.3	0.2
⑦	0.1	0.4	0.1	1.1	0.7	0.2	0.1
⑧	0.9	0.8	1.0	1.6	4.3	0.8	0.9
⑨	4.6	4.6	4.4	1.2	1.9	1.4	1.3
⑩	2.1	2.2	2.2	2.2	2.1	2.2	2.1
⑪	0	0	0	0.1	0	0	0
⑫	0.5	0.4	0.4	0.5	0.4	0.5	0.4
⑬	5.1	5.0	5.0	5.0	5.0	5.0	5.0
⑭	0.1	0.1	0	0	0.1	0	0
CN7-①	0	0	0.1	0.1	0.1	0	0.1
②	0	0.1	0.1	0	0	0	0

MODE CN No.	STOP	PLAY	REC	FWD. SEARCH	REV. SEARCH	PLAY PAUSE	REC PAUSE
CN8-①	0	0	0	0.1	0	0.1	0
②	0	0	0.1	0	0.1	0	0
③	0	2.9	2.9	3.0	3.0	2.9	3.3
④	0.1	2.8	2.9	3.0	2.9	2.9	3.3
⑤	0.1	2.9	3.0	3.0	3.0	2.9	3.3
⑥	3.6	3.5	3.6	3.6	3.6	3.6	3.6
⑦	4.3	4.3	4.3	4.3	4.4	4.3	4.2
⑧	3.6	3.6	3.6	3.5	3.7	3.6	3.6
⑨	0.9	0.8	0.8	0.8	0.9	0.8	0.8
⑩	0	0	0	0	0	0	0
⑪	2.2	2.2	2.2	2.2	2.4	2.2	2.2
⑫	0.8	0.8	0.8	0.8	0.8	0.8	0.8
⑬	2.3	2.2	2.2	2.3	2.2	2.2	2.3
CN9-①	0.1	0	0	0	0	0	0
②	0.1	0.1	0	0.1	0	0	0
CN10-①	4.3	2.2	2.1	2.1	2.1	2.1	2.1
②	4.3	2.8	2.7	2.6	2.9	2.4	2.9
③	6.5	4.6	2.4	5.0	5.2	5.2	2.4
④	6.4	4.5	2.3	5.4	5.0	5.2	2.2
⑤	0	0.1	0.1	0	0	0	0
⑥	0.1	5.0	2.3	5.1	4.3	5.0	2.1
⑦	6.5	4.4	2.4	5.1	5.3	0	1.4
⑧	0	0	0.1	0.1	0	0	0
CN11-①	5.0	5.0	0.1	0	0	0.1	5.0
②	5.2	5.2	5.1	5.1	5.1	5.1	5.1
③	0.1	0.1	0	0.2	0.2	0.2	0.1
④	2.9	3.9	3.8	4.1	4.1	3.9	4.2
⑤	0	0.1	0	0	0	0	0
⑥	0.1	0	0.1	0	0	0.1	0
⑦	0	0	0	0	0	0.1	0.1
⑧	0.1	0	0	0	0.1	0	0
⑨	5.0	5.0	5.0	5.0	5.0	5.0	5.0
⑩	6.6	6.4	6.4	6.7	6.6	6.4	6.9
⑪	0.1	0	0	0	0.1	0	0.1
⑫	10.1	10.1	10.1	10.1	10.0	10.1	10.1
⑬	5.1	5.2	5.2	5.1	5.1	5.1	5.1
CN12-①	5.1	5.2	5.1	5.1	5.2	5.2	5.1
②	0.1	0	0	0	0	0	0
③	0.5	2.8	2.8	3.2	2.6	2.5	4.6
④	0	2.8	2.8	2.4	2.7	2.5	4.5
⑤	0.1	0	0	0	0	0.1	0.1

**0 4 Audio/Servo Platte (Steckeranschlüsse)
Audio/Servo PWB (Connectors)**

MODE CN No.	STOP	PLAY	REC	FWD. SEARCH	REV. SEARCH	PLAY PAUSE	REC PAUSE
CN2-①	7.9	5.1	7.5	5.3	5.3	5.3	7.9
②	7.9	5.1	7.5	5.3	5.3	5.4	8.0
CN3-							
①	0	0	0	0	0	0	0
②	0	0	0	0	0	0	0.1
③	0	0	0	0	0	0.1	0.1
CN4-							
①	0	0	0	0.1	0.1	0	0
②	4.3	4.2	4.3	4.2	4.2	4.2	4.3
③	2.0	1.8	1.8	1.7	1.7	1.6	1.6
CN5-							
①	0	0	0	0	0	0.1	0
②	0	0	0	0	0	0	0
③	7.9	7.9	7.7	7.9	8.0	8.0	7.9
CN11-							
①	5.0	0	0.1	0	0	0	0
②	5.0	0.1	0.1	0	0	5.0	5.0
③	0	5.0	5.1	4.9	0	5.0	5.0
④	0	0	0.1	0	0	0	0
CN12-							
①	2.4	0.1	0.1	2.5	0	2.3	0.2
②	0	0	0	0.1	0.1	0	0
③	0.1	0.1	0	0.1	0.1	0.1	0
CN13-							
①	0	0.1	0.1	0	0	0	0
②	0	0.1	0	0	0	0.1	0
CN14-							
①	0	0	0	0	0.1	0	0.1
②	0	0	0.1	0	0	0.1	0.1
③	0.1	2.2	2.2	5.8	0.1	1.8	0
④	0	0.1	0	0.1	0	0.1	0
⑤	0	0	0.1	0.1	6.3	0.1	0.1

**0 8 Verbindungsplatte
Junction PWB**

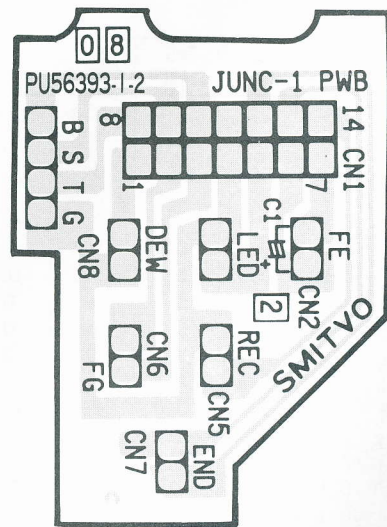

**0 6 Löschkopfplatte
Full erase head PWB**

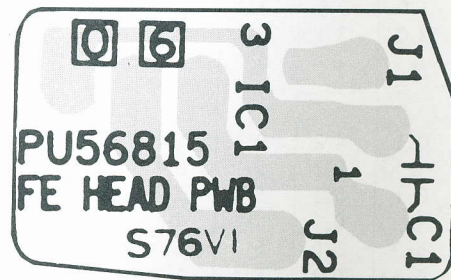

**0 5 Tastenplatte
Operation PWB**

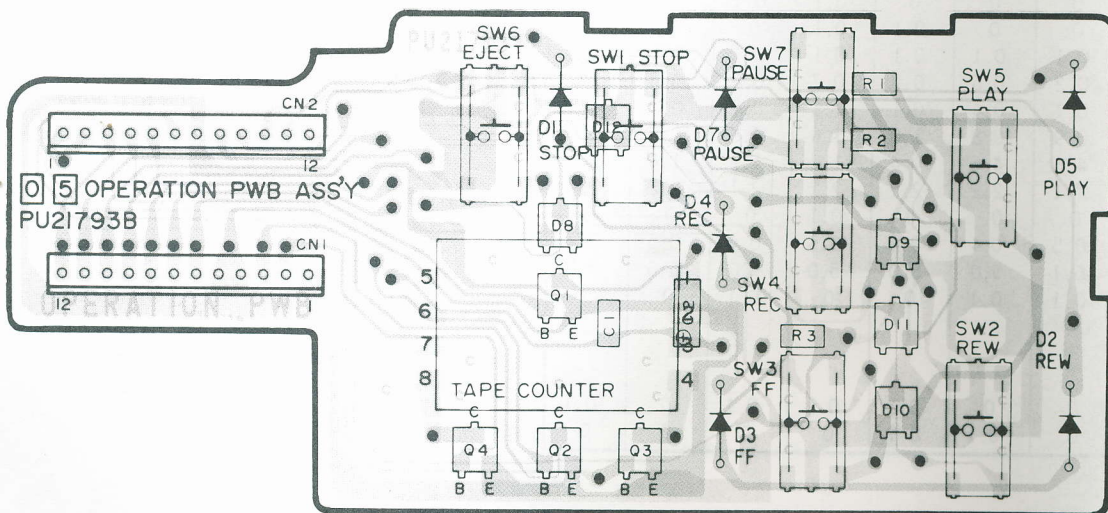

Mechaniksteuerung Schaltbild Mechacon circuit diagram

MCM1053



DTC114YK

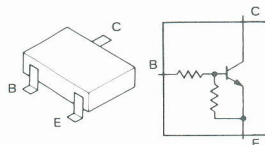

GL-1HD202

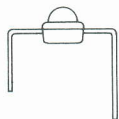

MA151WA

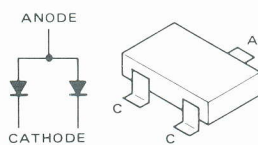

OPERATION

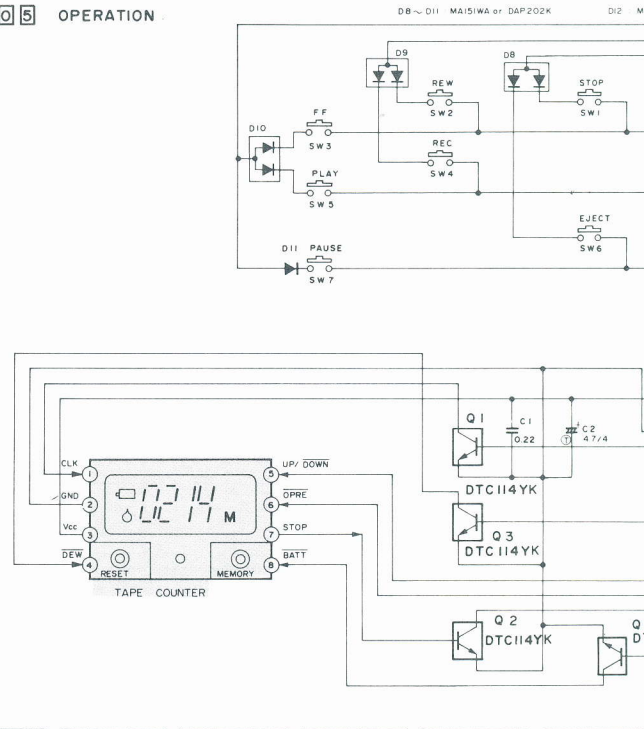

NOTES: Unless otherwise specified.

1. All resistance values are in ohms.
2. All inductance values are in H.
3. All capacitance values are in μF .

: Chip capacitor

: Electrolytic capacitor

: Non-polar capacitor

: Tantalum capacitor

: Polypropylene capacitor

: Mylar capacitor

4. Shaded () parts are critical for safety. Replace only with specified part numbers.
5. The digital transistor is a transistor that includes built in resistors. Both PNP and NPN transistors are available.



Hinweis:

Bauteile in den schattierten Flächen sind Sicherheitsbauteile! Nur gegen Original-Ersatzteile wechseln!

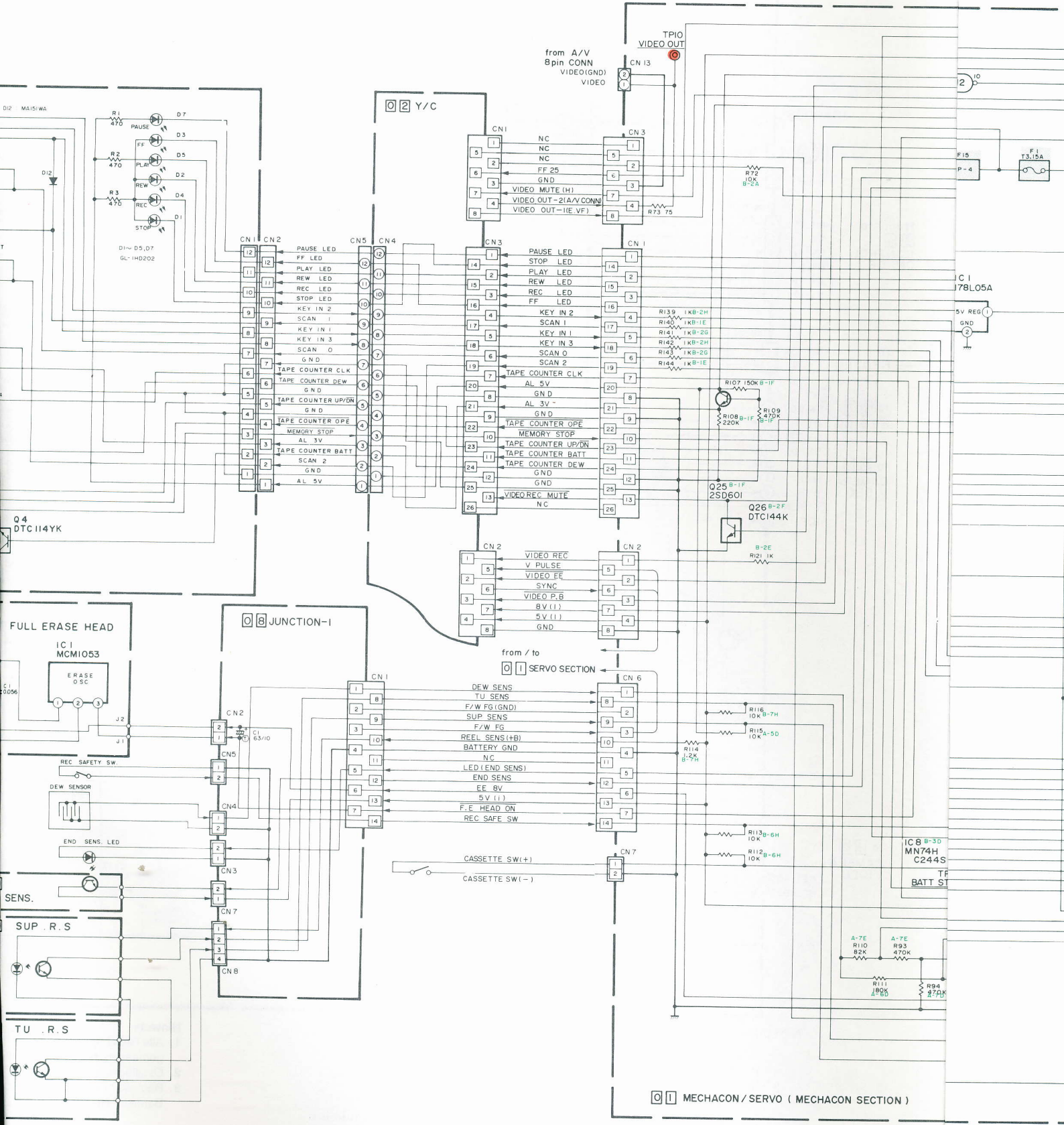

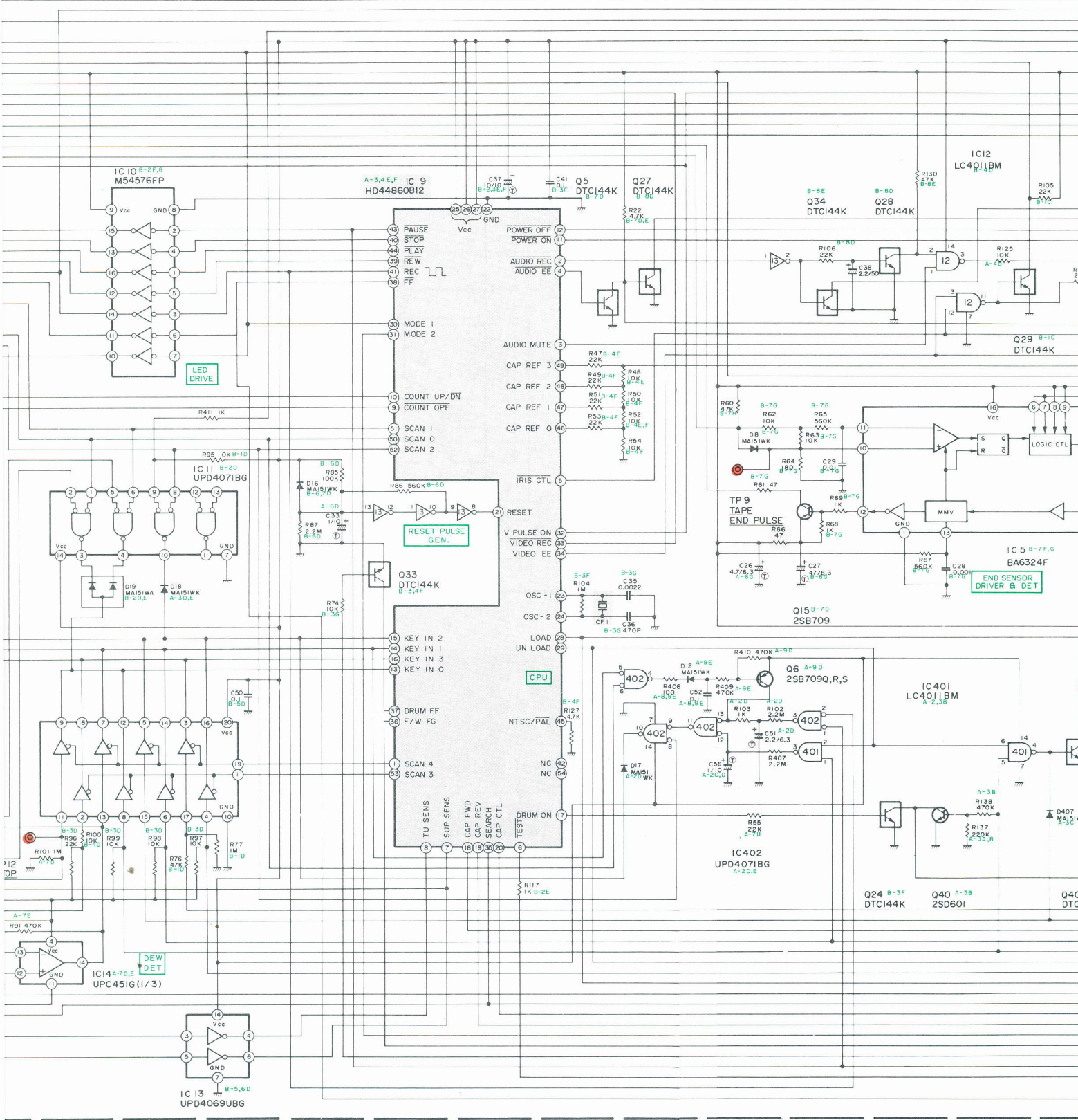

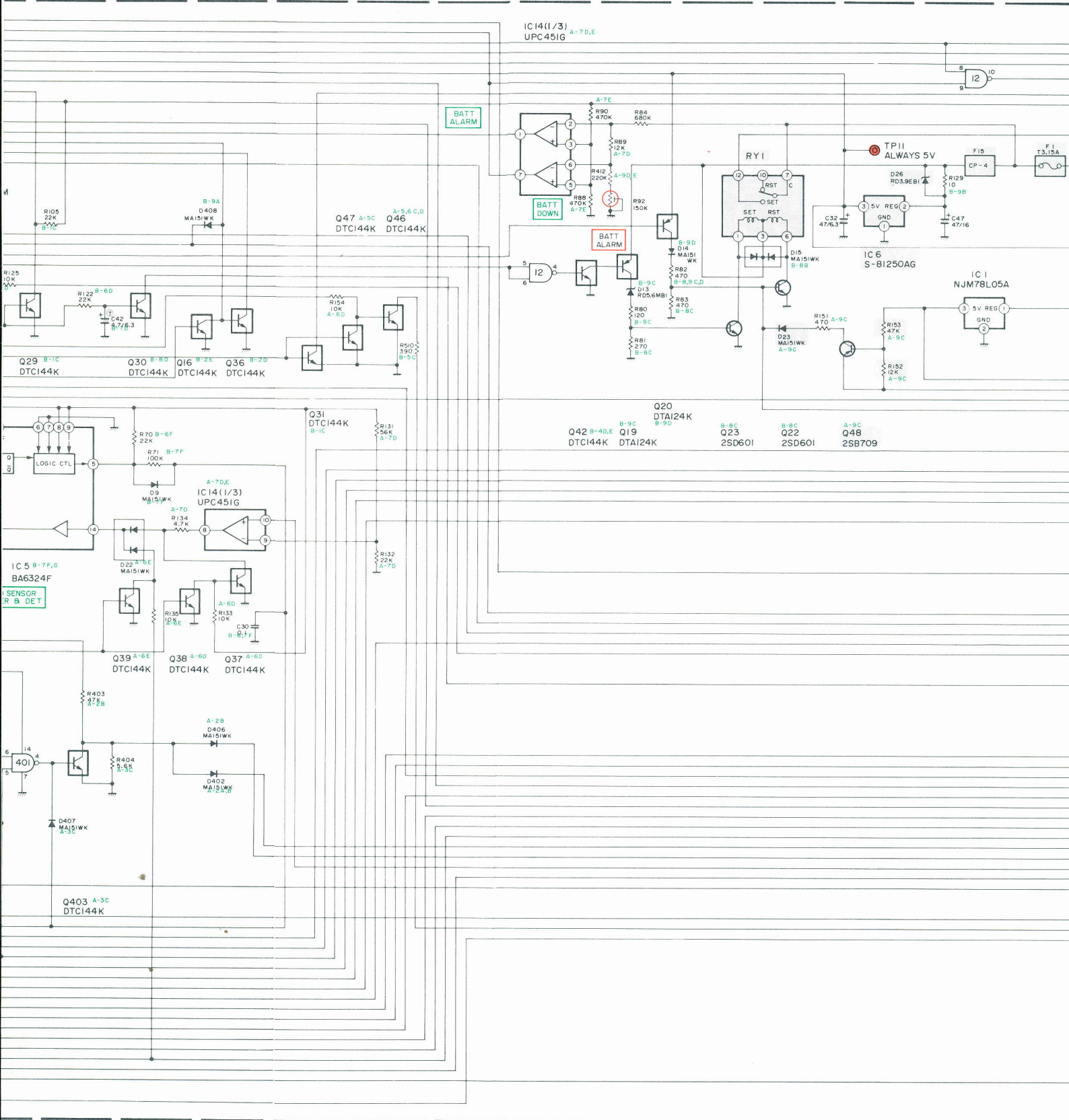

Mechaniksteuerung Schaltbild
 Mechacon circuit diagram

(Schlüsse)
 (Location)

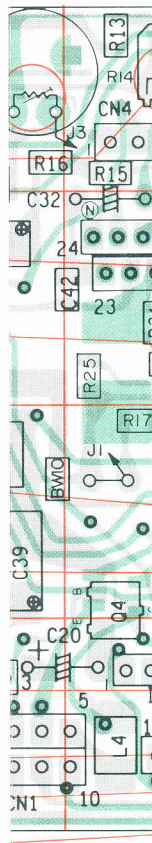
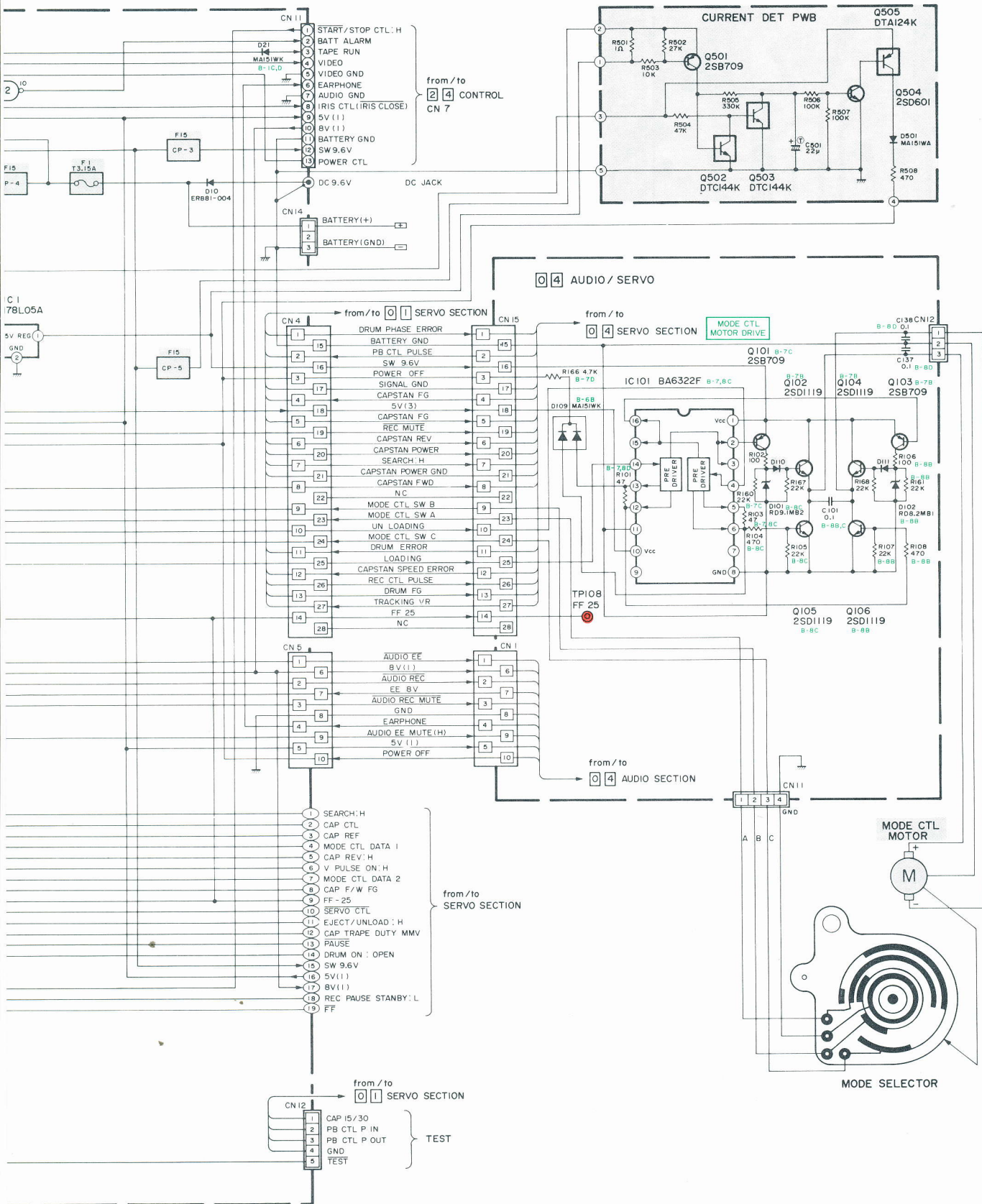

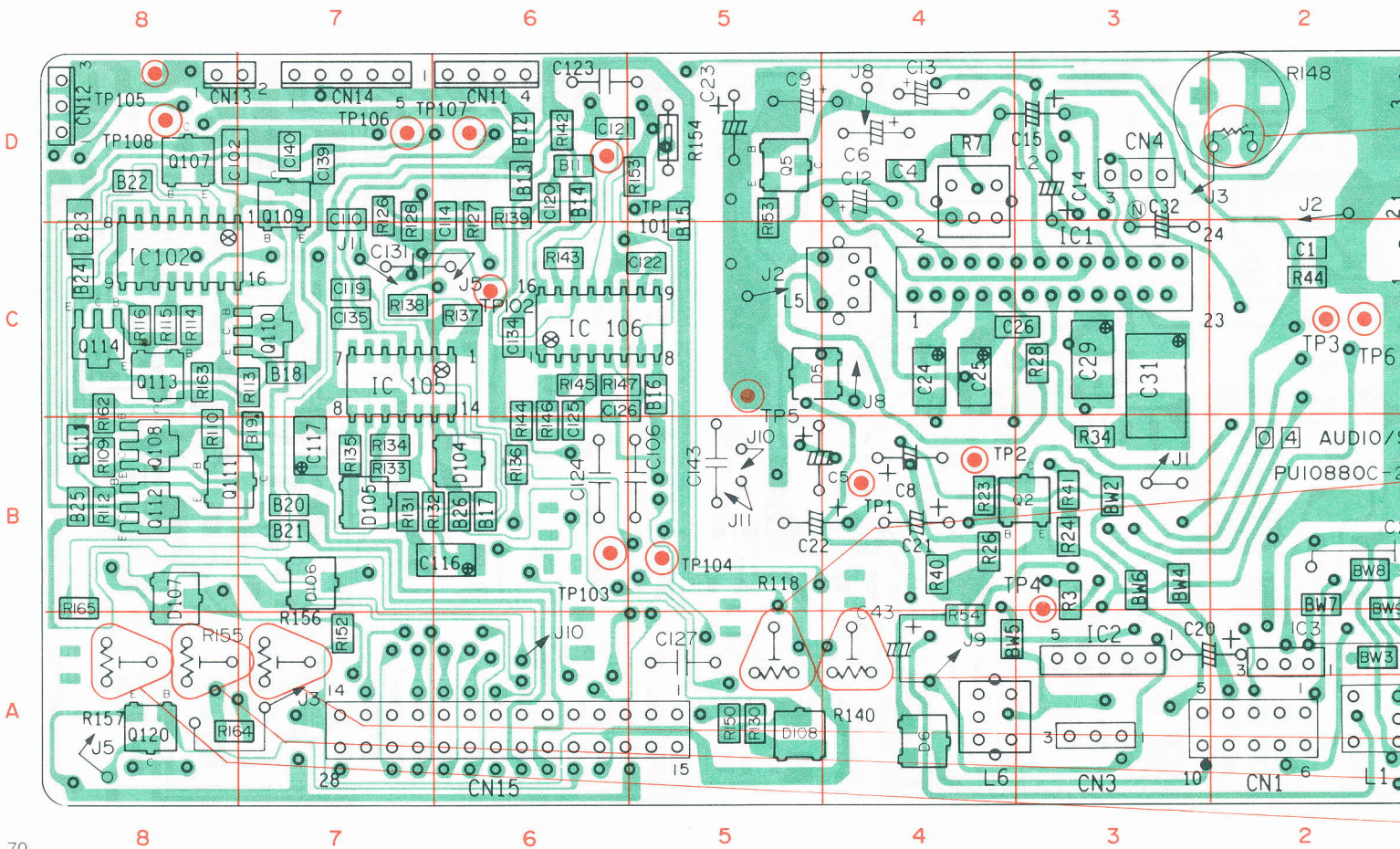
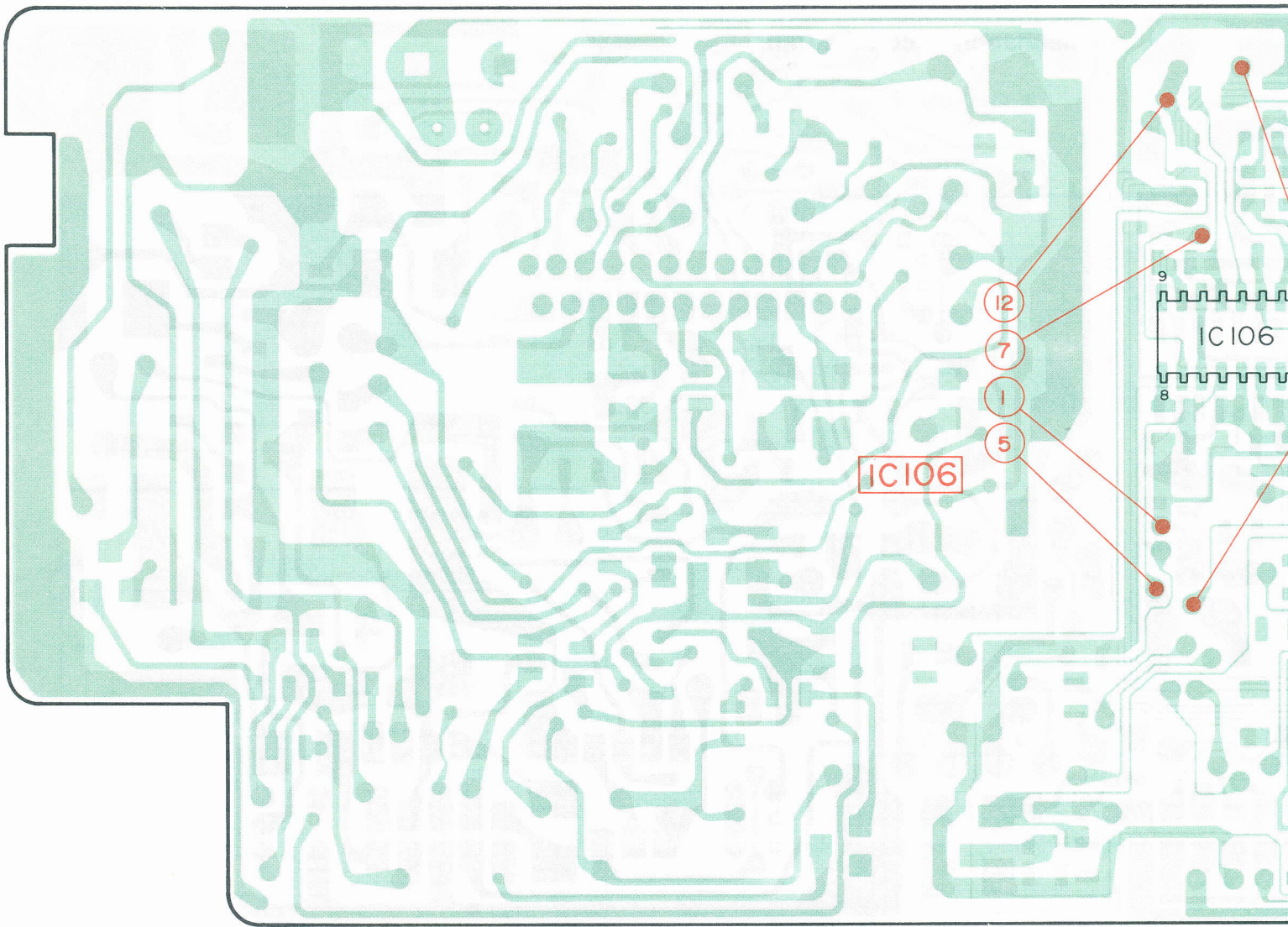

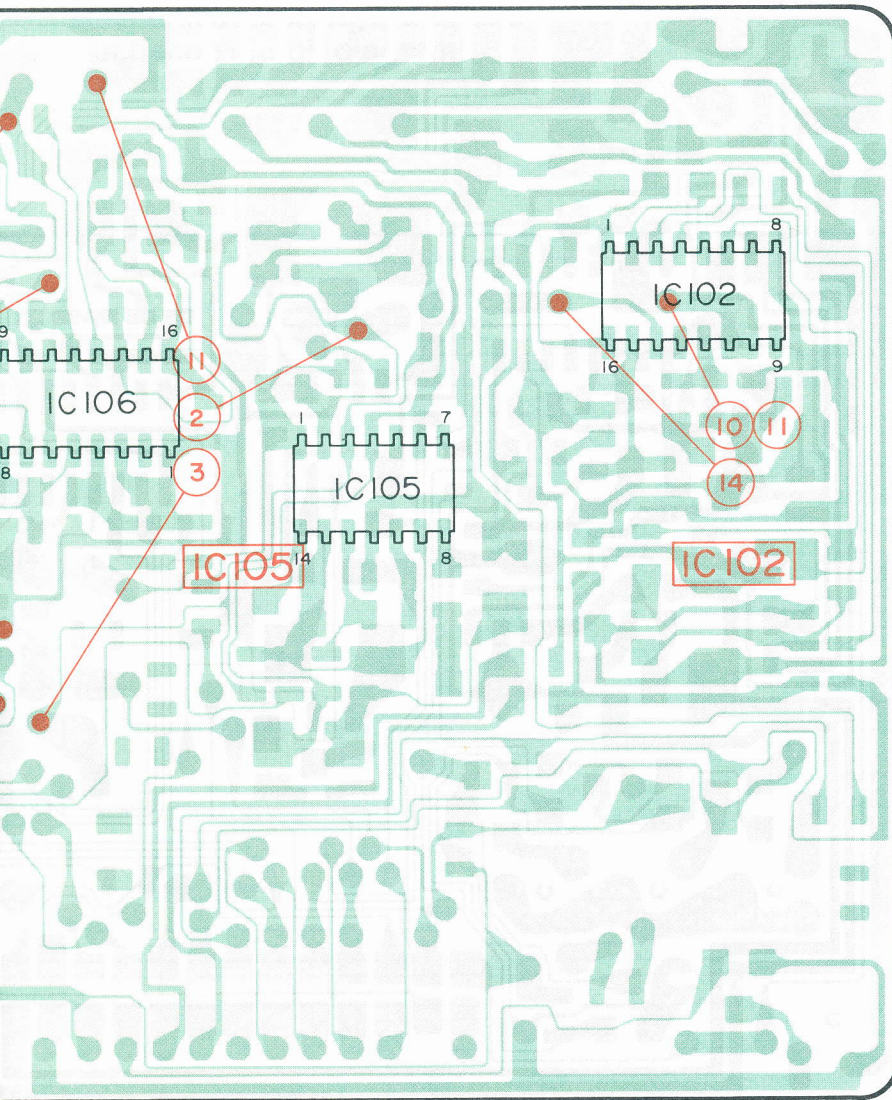

0 4 (Audio)-Servoplatte (IC-Anschlüsse)
 (Audio)-Servo PWB (IC-pin tocation)

2 1 — Front —

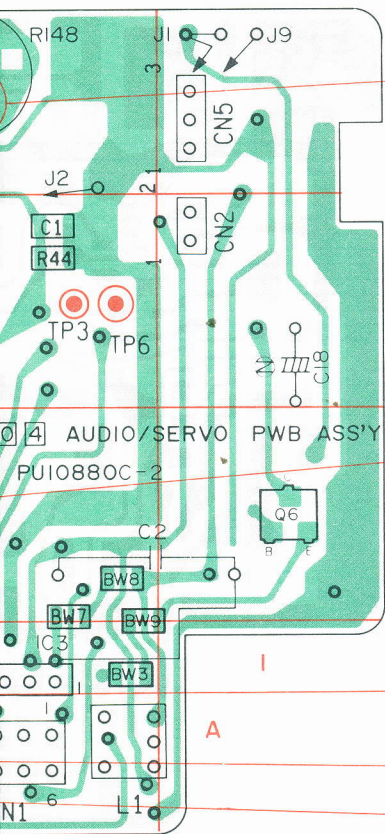

— Rear — 1 2

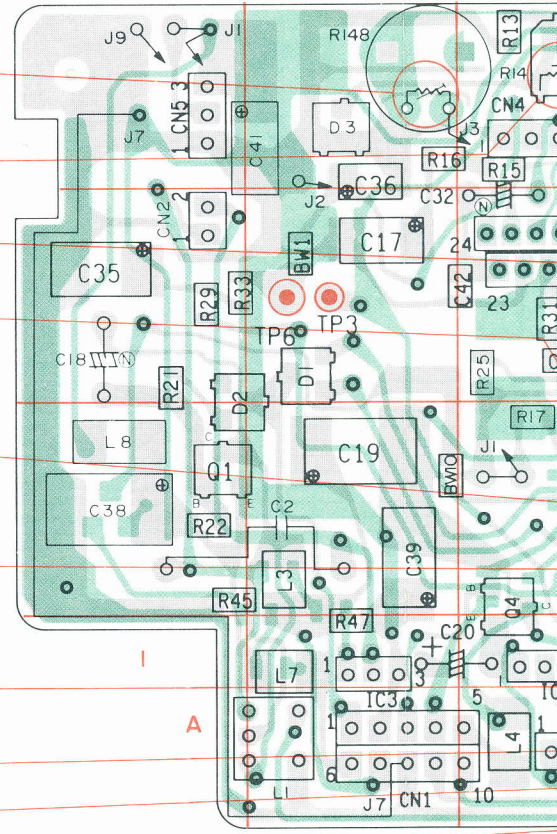

R148 TRACKING VR

R14 EE LEVEL

R27 REC LEVEL

R30 PB LEVEL

R118 CAPSTAN SAMPLE POSITION

R2 BIAS LEVEL

R140 DRUM SAMPLE POSITION

R156 SEARCH FF PHASE

R155 SEARCH REW PHASE

R157 TRACKING PRESET

schlüsse)
location)

Funktion IC 1 (Ablenplatte)
Function IC 1 (Def + SSG PWB)

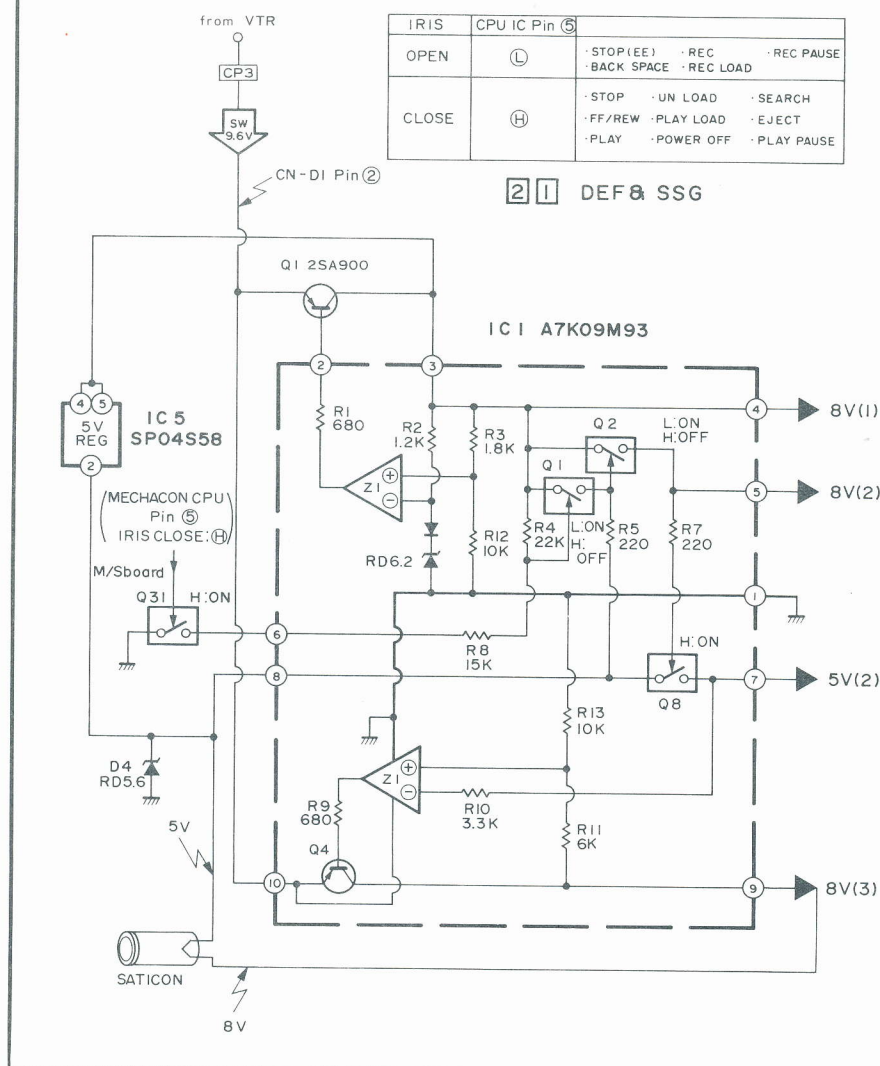

from / to
2 4
CONTROL
CN-C6

to
HEATE

to 2 3
EE&IN

to 2 2
CAMER
VIDEO

3 4 5 6 7 8

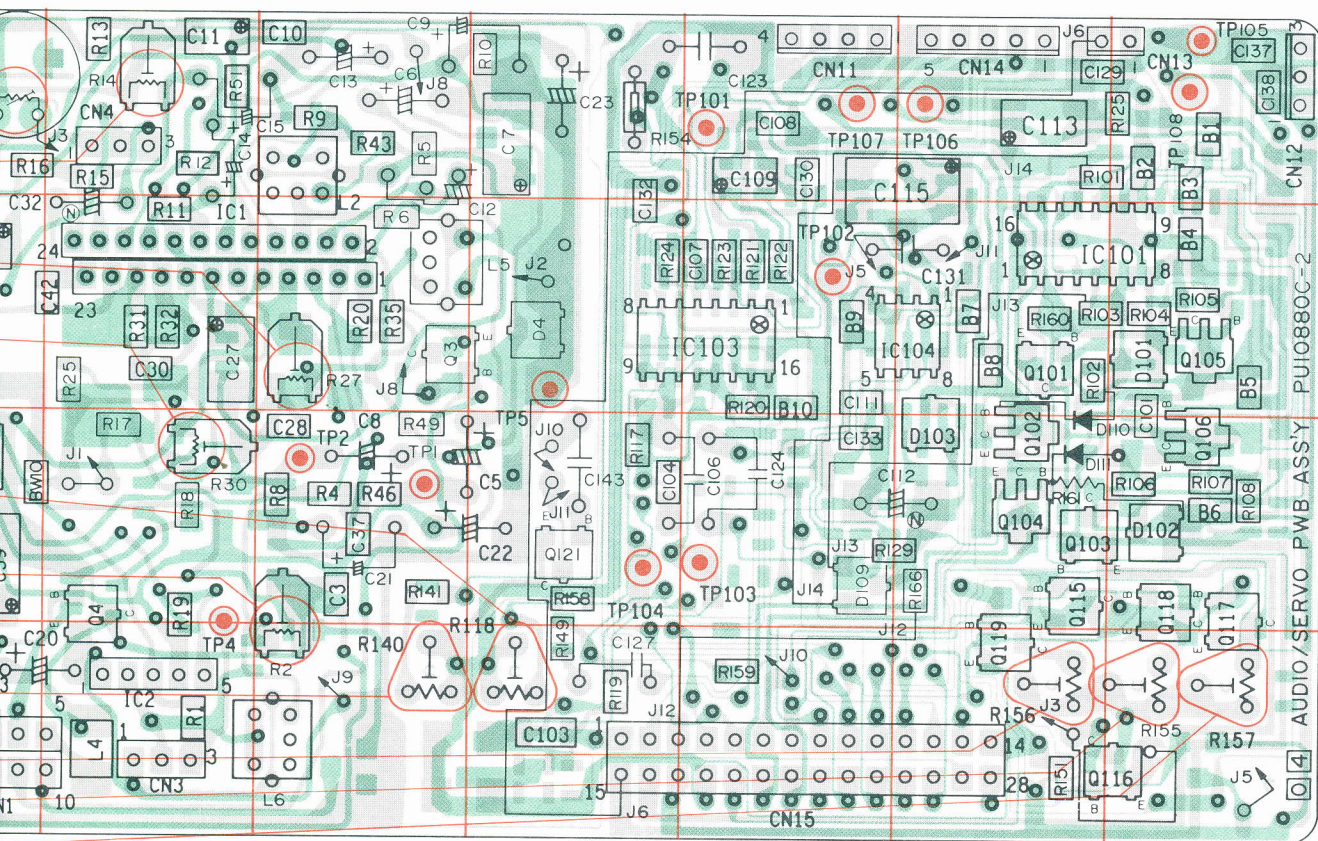

to 2 2
CAMER
VIDEO

3 4 5 6 7 8

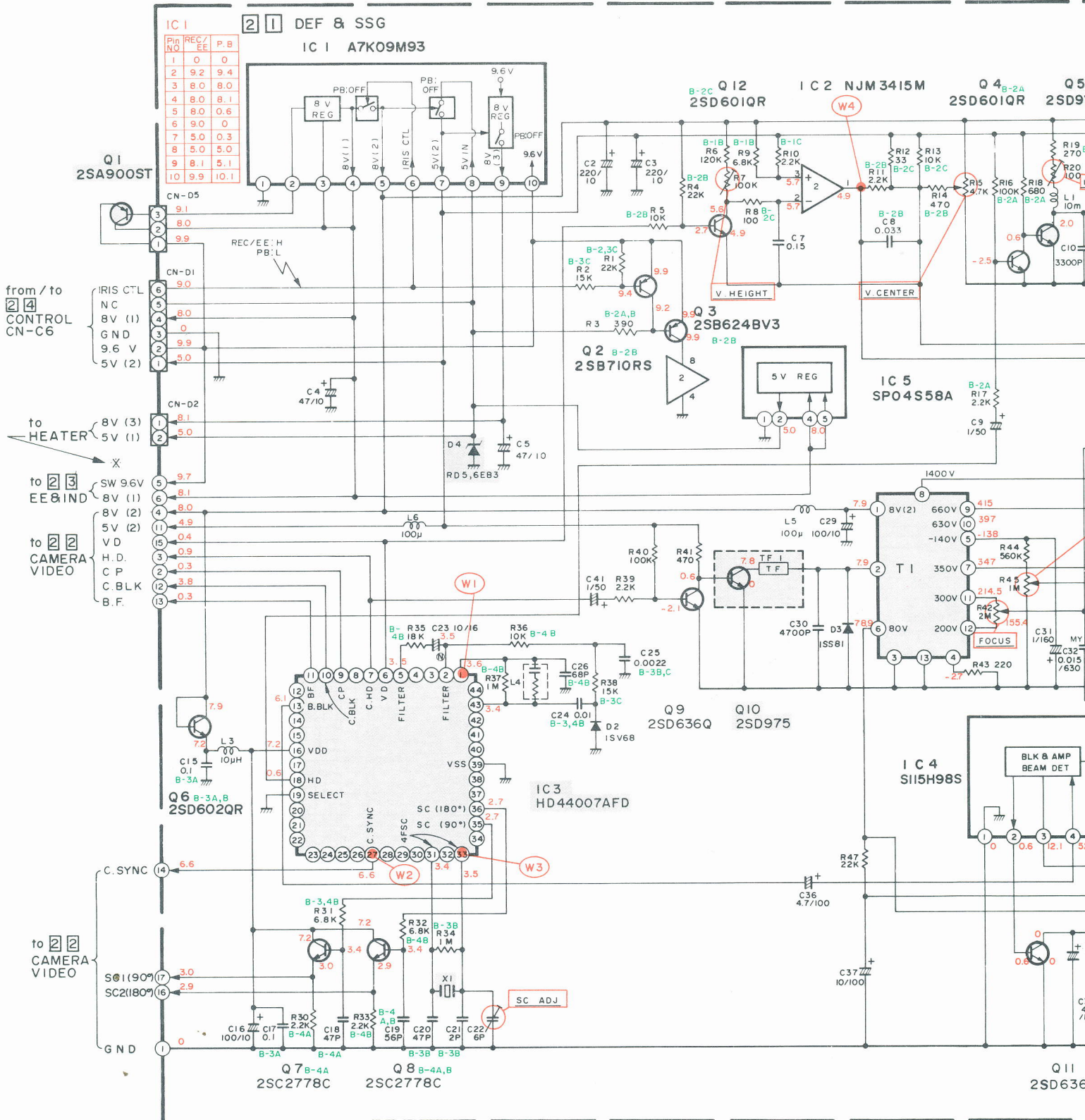

NOTES:

- parts are importantly related to safety. When replacing them, make sure to use specified parts.
- Voltage and waveform measurements. Voltage: Measured with digital voltmeter in DC range at iris closed. Waveform: With greyscale completely filling the picture area at auto-iris.

Hinweis:

- Alle Gleichspannungen sind mit einem Digital-Voltmeter gemessen, bei geschlossener Blende.
- Oszillogramme: Grautreppe, Blende auf Automatik.
- Bauteile in schraffierten Flächen sind Sicherheits-Bauteile! Nur gegen Original-Ersatzteile wechseln!

2 1 Ablenkplatte Schaltbild DEF + SSG circuit diagram

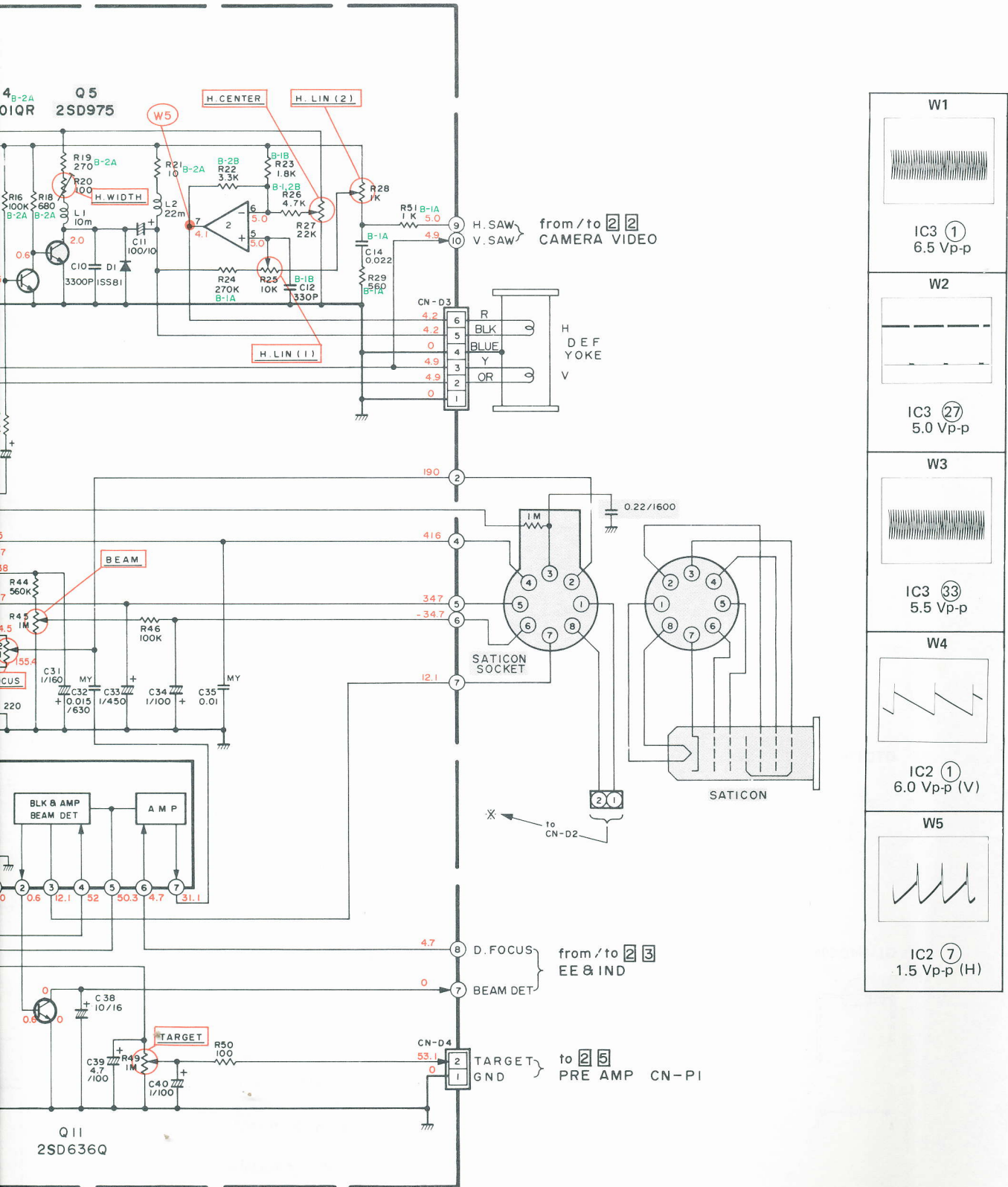

NOTES: Unless otherwise specified.

1. All resistance values are in ohms.
2. All inductance values are in H.
3. All capacitance values are in μF .

: Chip capacitor

: Mylar capacitor

: Electrolytic capacitor

: Non-polar capacitor

: Tantalum capacitor

: Polypropylene capacitor

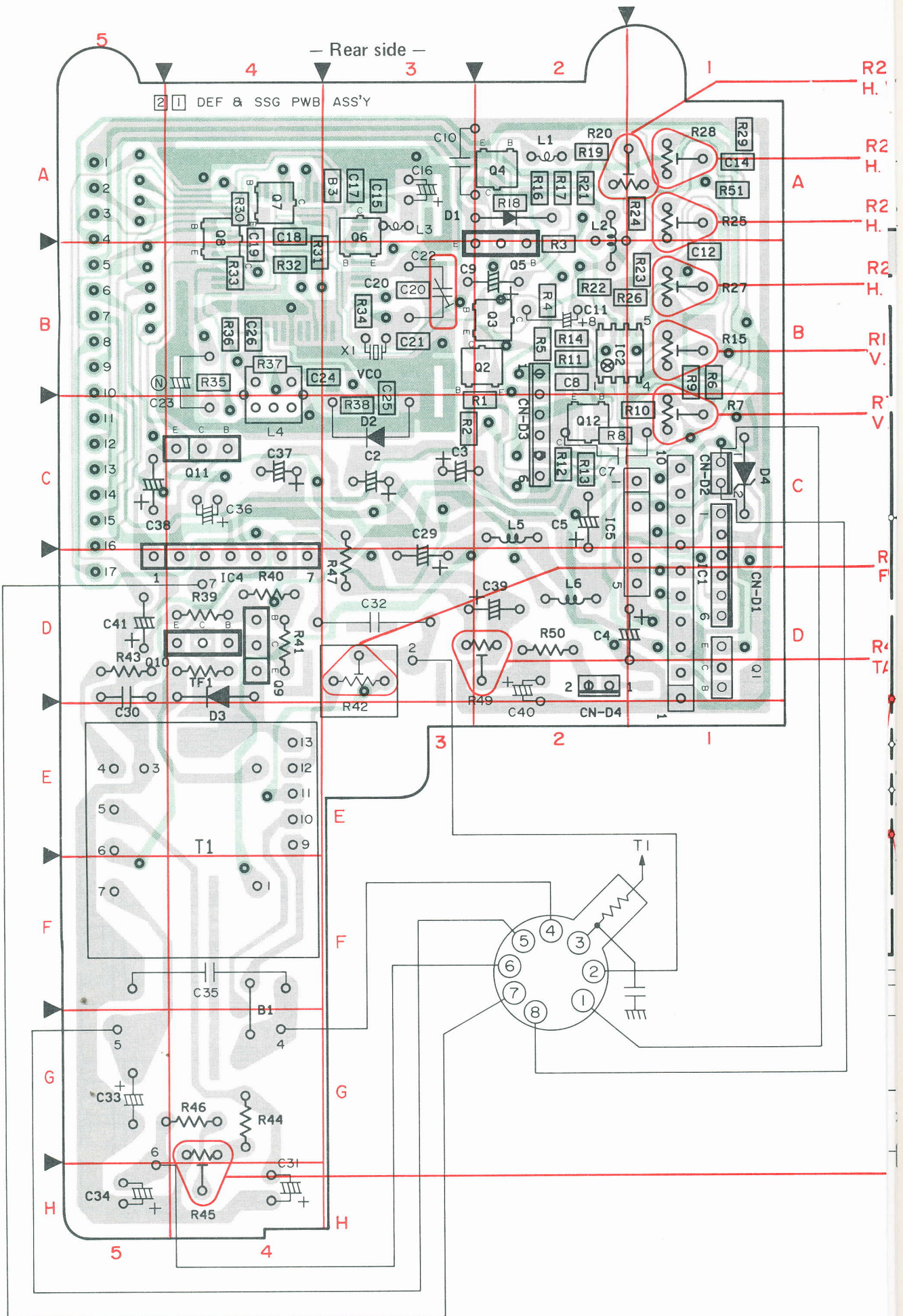

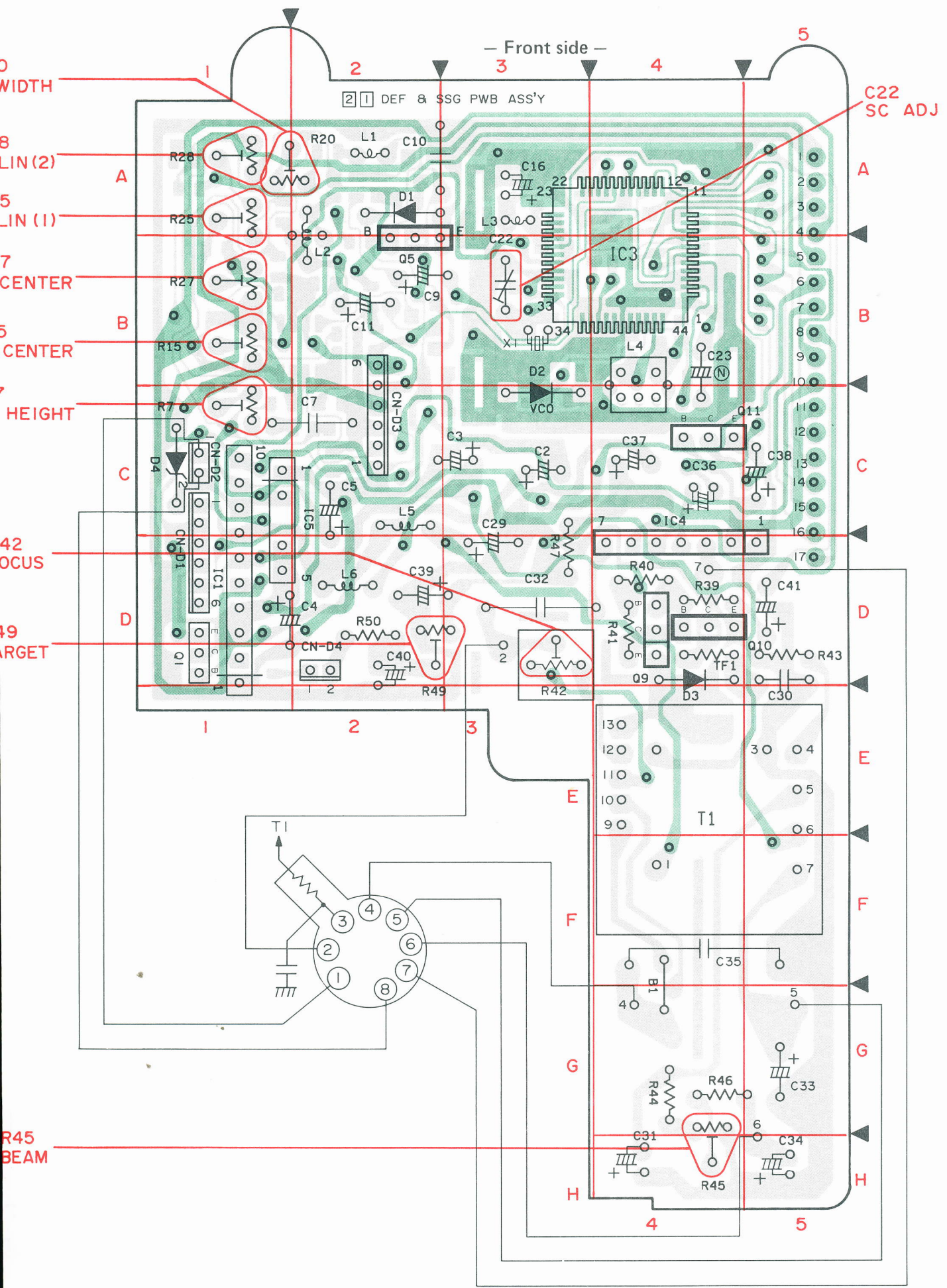

2 1 Ablenplatte
DEF + SSG PWB

A7K09M93

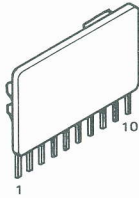

NJM3415M

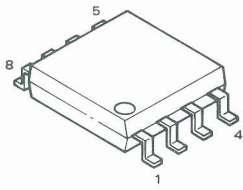

HD44007AFD

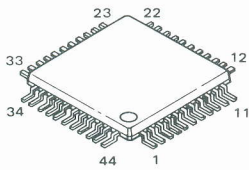

S115H98S

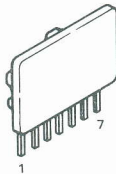

SP04S58A

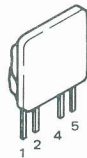

2SA900ST

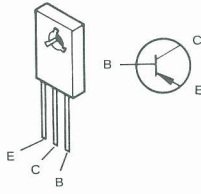

2SD975

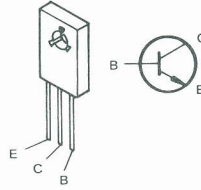

2SD636Q

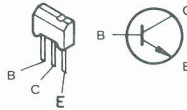

**2SB624BV3
2SB710RS**

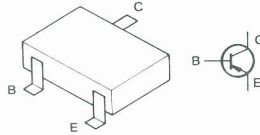

**2SC2778C
2SD601QR
2SD602QR**

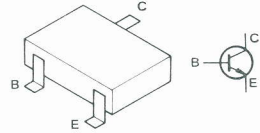

RD5.6EB3

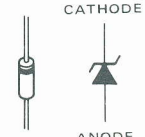

1SV68

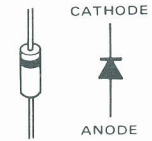

1SS81

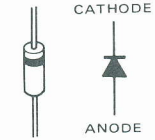

from/to
2 3 EE & IND

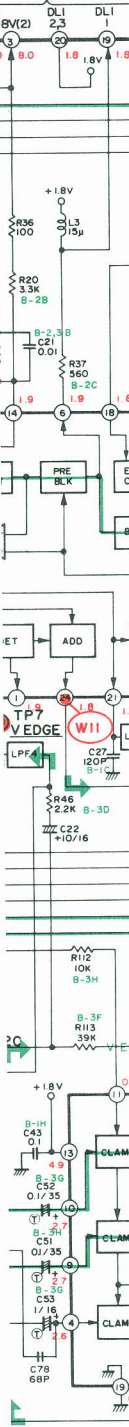

**IC5
HA11776AMP
B-26**

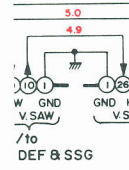

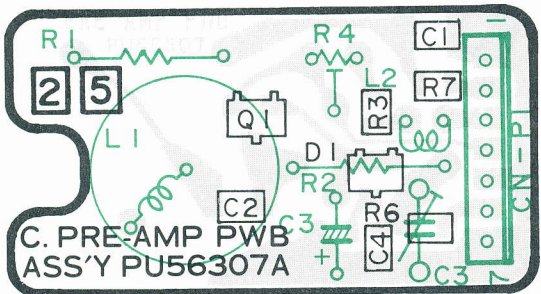
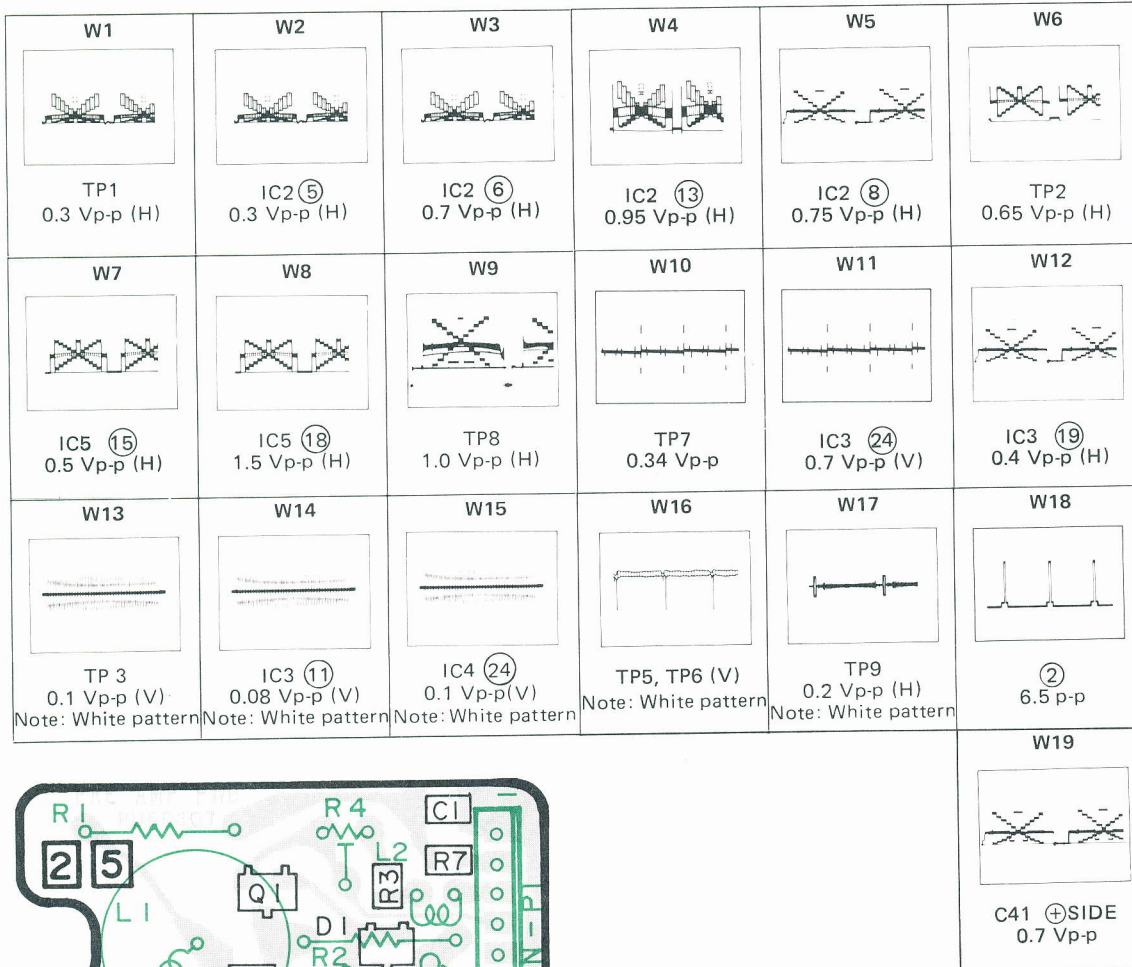

2 5 Vorverstärker Preamplifier

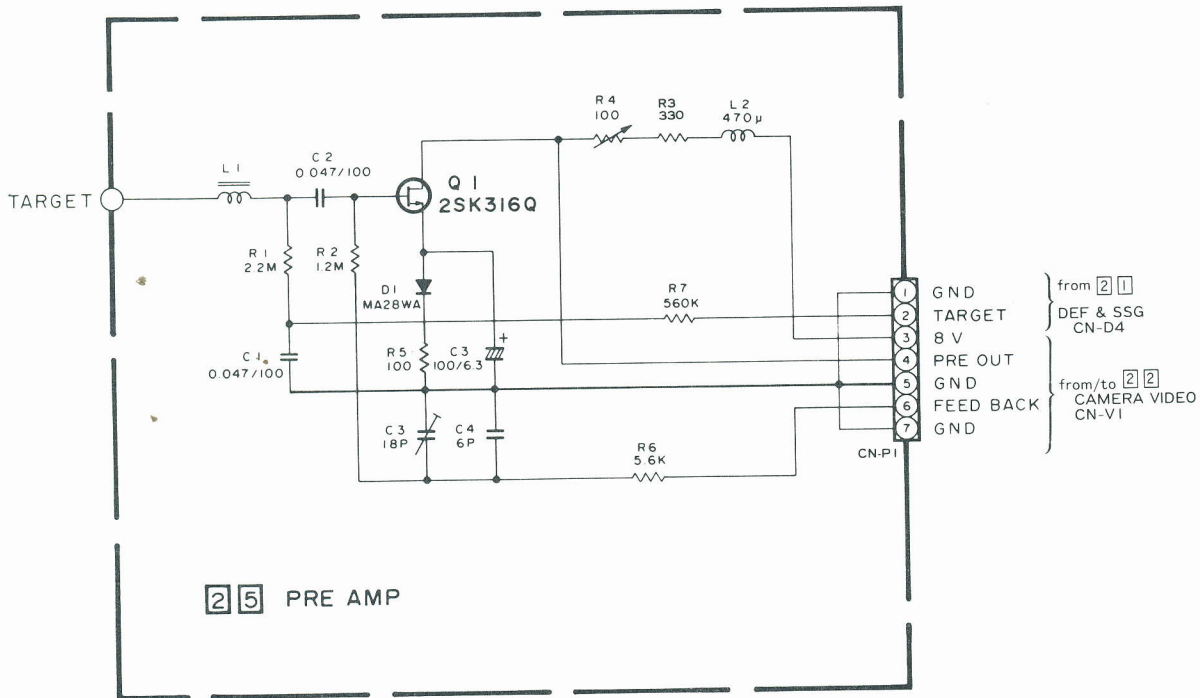

NOTES: Camera amp R4 and C3 are adjusted at the factory.
 Replace the entire camera pre-amp ass'y as a unit.
 Readjustment of R4 and C3 is not required, even after replacing the Saticon.

Hinweis:
 R4 und C3 sind fest eingestellt.
 Ein Abgleich ist nicht erforderlich.

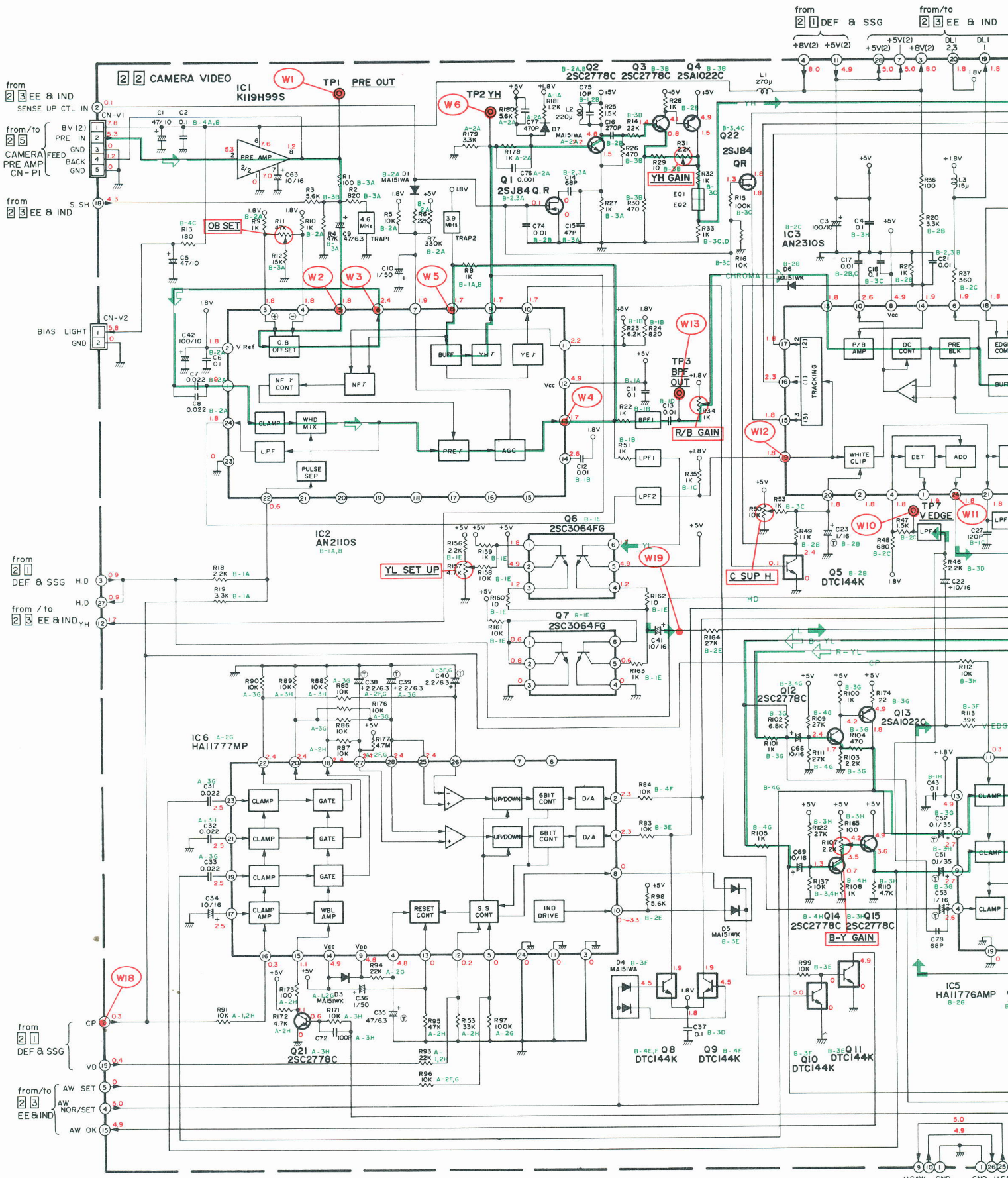

NOTES:

- Parts are importantly related to safety. When replacing them, make sure to use specified parts.
- Voltage and waveform measurements
 Voltage: Measured with digital voltmeter in DC range at iris closed
 Waveform: With greyscale completely filling the picture area at auto-iris

2 2 Videoplatte (Camera) Schaltbild Video PWB (Camera) circuit diagram

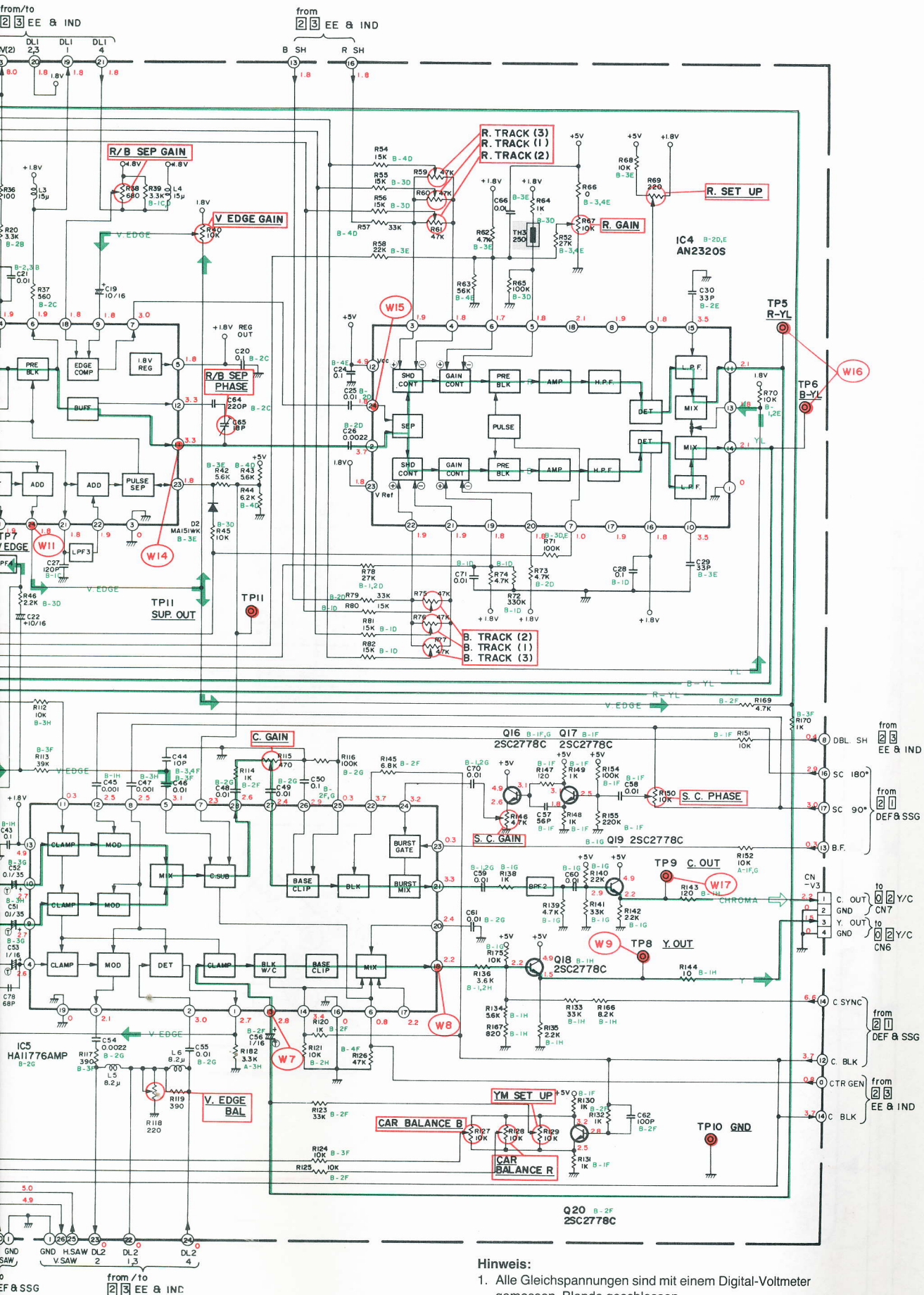

Hinweis:

1. Alle Gleichspannungen sind mit einem Digital-Voltmeter gemessen. Blende geschlossen.
2. Oszillogramme: Grautreppe, Blende auf Automatik.
3. Bauteile in schattierten Flächen sind Sicherheitsbauteile! Nur gegen Original-Ersatzteile auswechseln!

2 3

E-E &
IND



— Flexible board —

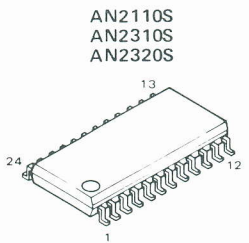
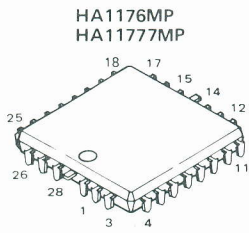

K119H99S

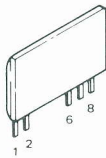

2SC3064FG

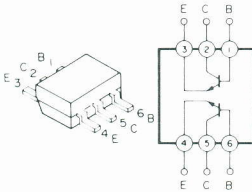

DTC144K

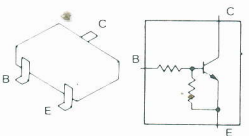

2SA1022C

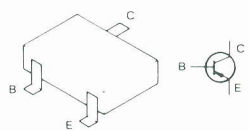

MA151WA

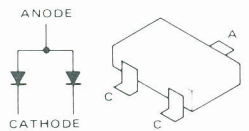

2SJ84QR

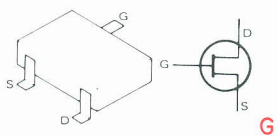

2SC2778C

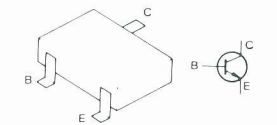

MA151WK

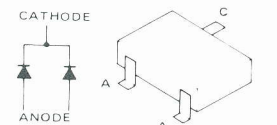

- Rear side -

2 1
DEF &
SSG



1
2
3
4
5
6
7
8
9
10
11
12
13
14
15
16
17

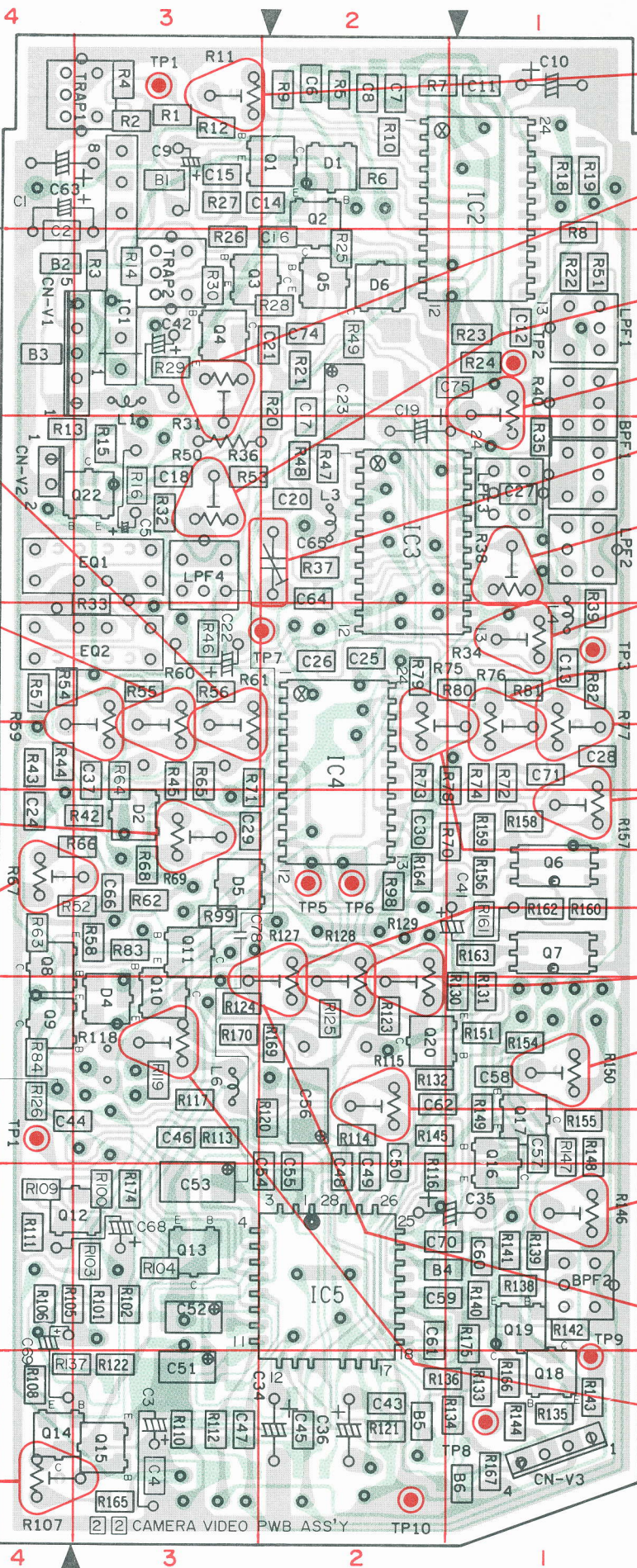

R61
R TRACK (3)

R60
R TRACK (2)

R59
R TRACK (1)

R69
R SET UP

R67
R GAIN

To 2 3
EE & IND PWB
①

R107
B-Y GAIN

R11
OB SE

R31
YH GA

R50
C SUP

R40
V EDGE C

C65
R/B SEP P

R38
R/B SEP C

R34
R/B GA

R76
B TRACK

R77
B TRACK

R157
YL SET

R75
B TRACK

R128
CAR BALAN

R129
YH SET

R150
SC PHA

R115
C GAIN

R146
SC GAI

R127
CAR BALAN

R118
V EDGE B

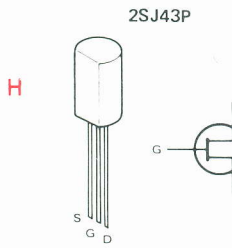
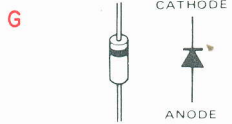
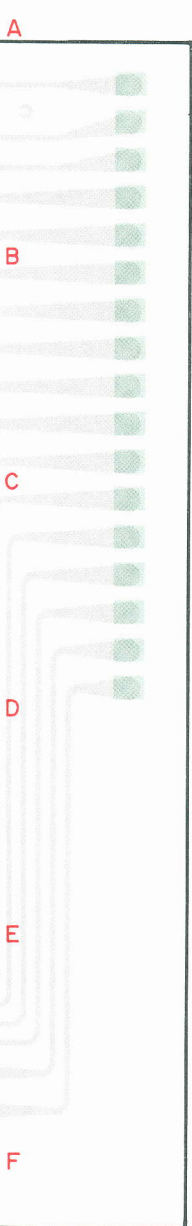

**2 2 Videoplate (Camera)
Video PWB (Camera)**

— Front side —

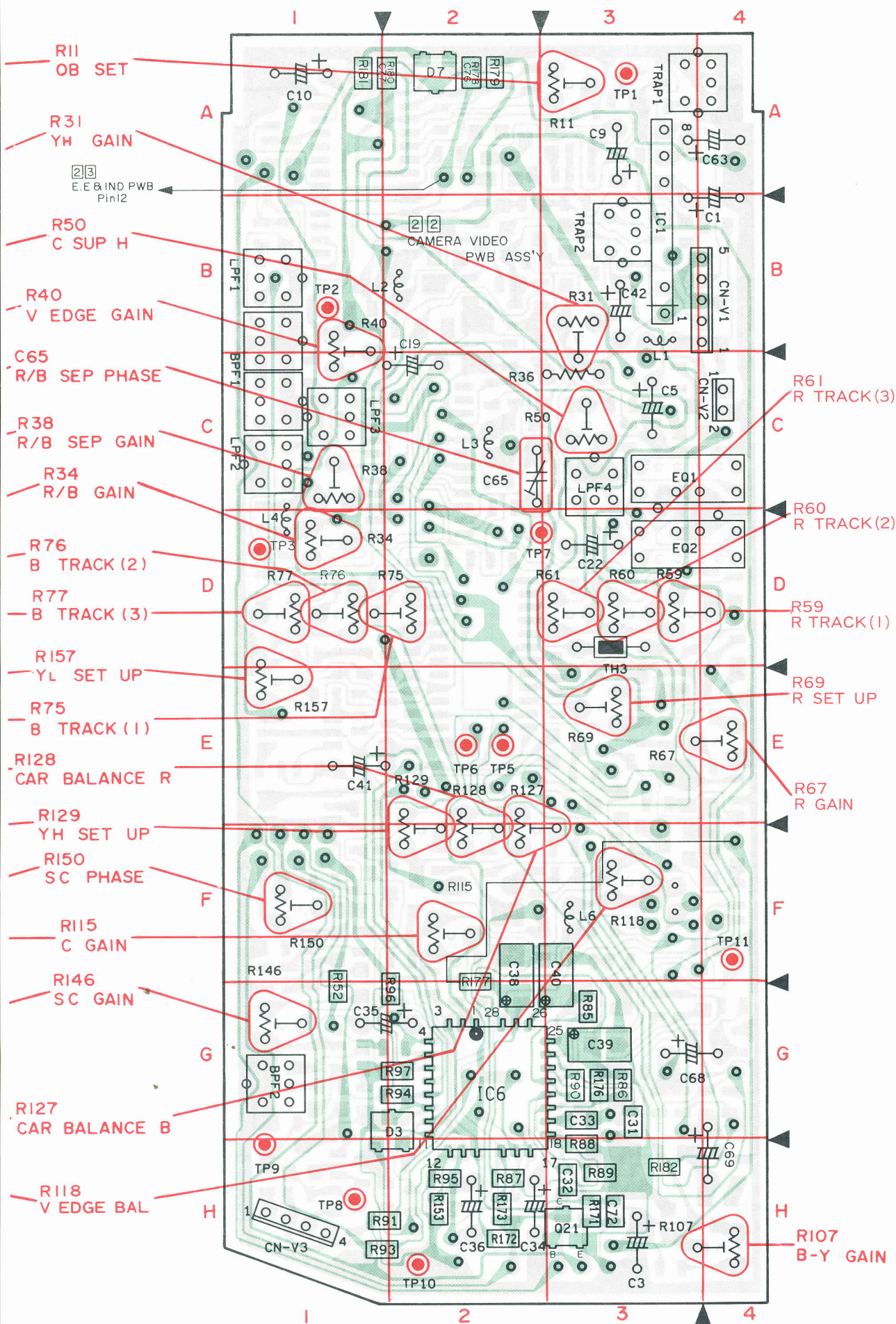

Legend symbols and values:

- IC 2.7 V
- IC 2.8 V
- IC
- IC
- IC
- 5.5 V

2 3 E-E und Anzeigenplatte E-E and indicator

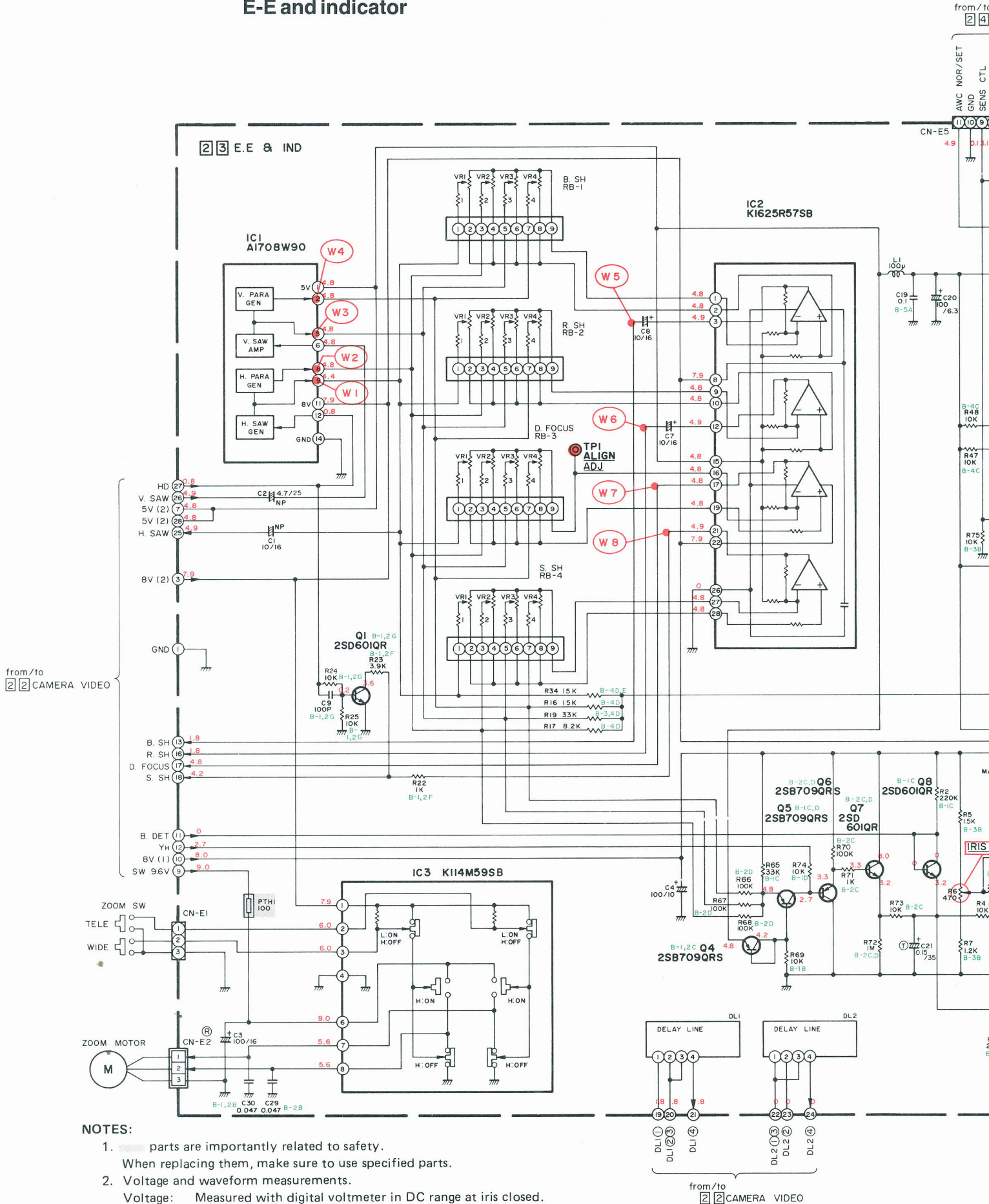

NOTES:

1. **parts are importantly related to safety.**
When replacing them, make sure to use specified parts.
2. **Voltage and waveform measurements.**
Voltage: Measured with digital voltmeter in DC range at iris closed.
Waveform: With greyscale completely filling the picture area at auto-iris.

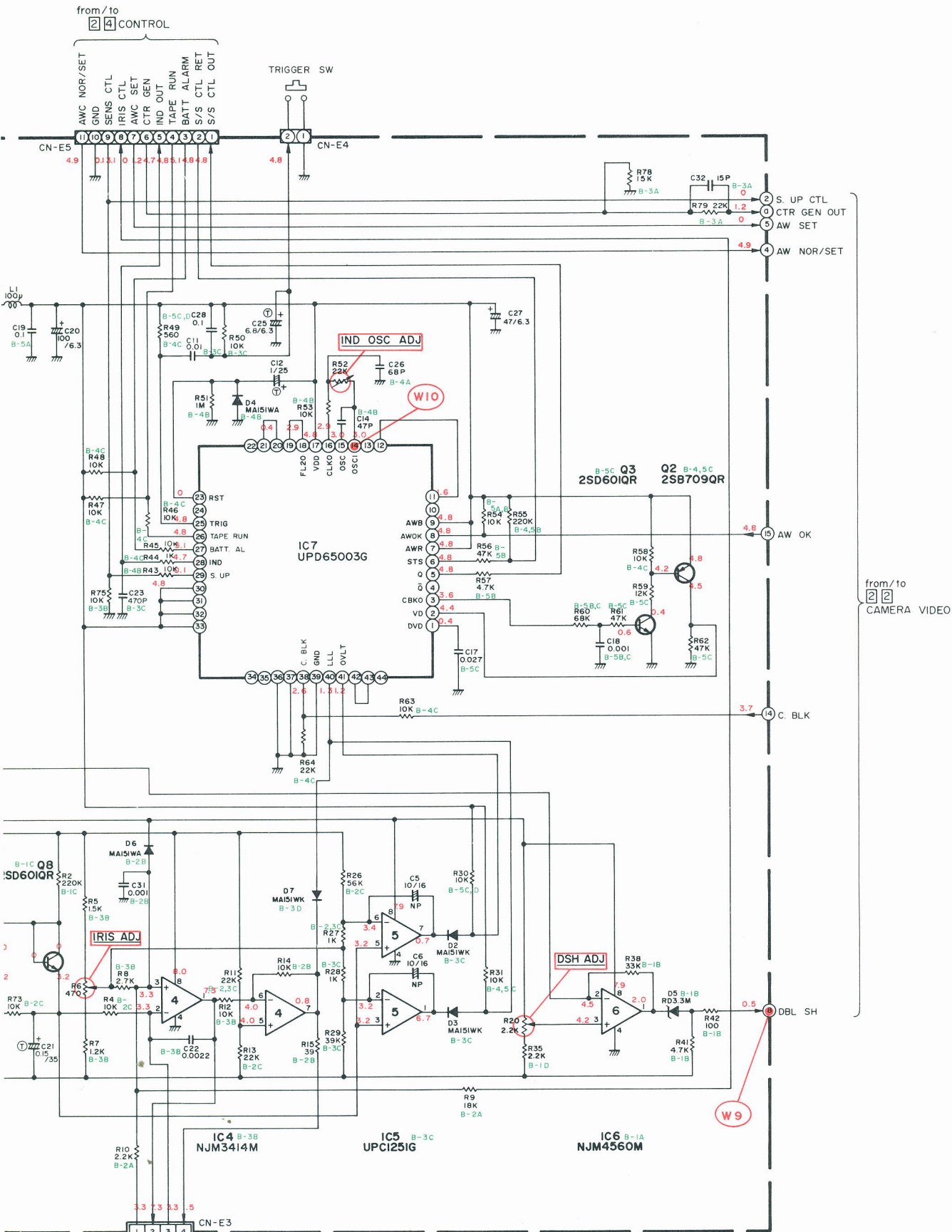

Hinweis:

1. Alle Gleichspannungen sind mit einem Digitalvoltmeter gemessen, bei geschlossener Blende.
2. Oszillogramme: Grautreppe, Blende auf Automatik.
3. Bauteile in den schattierten Flächen sind Sicherheitsbauteile! Nur gegen Original-Ersatzteile auswechseln!



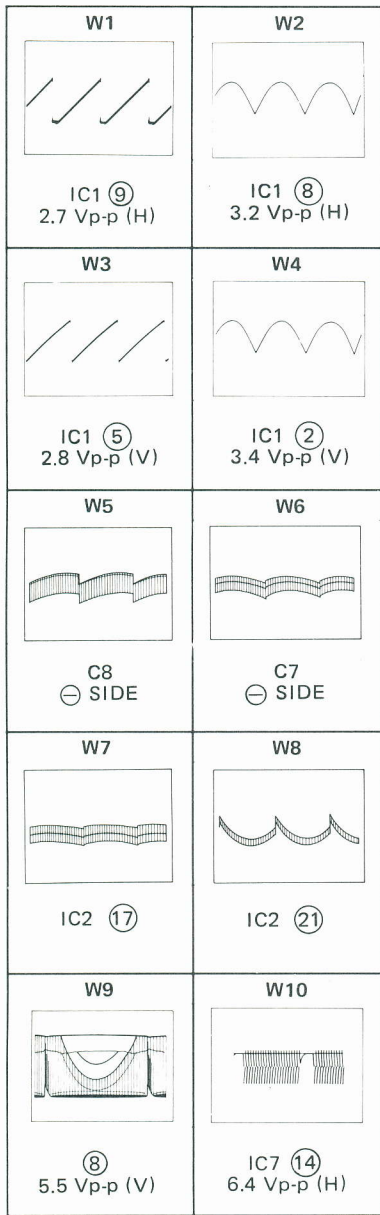

**2 4 Camera Schalterplatte
Camera control PWB**

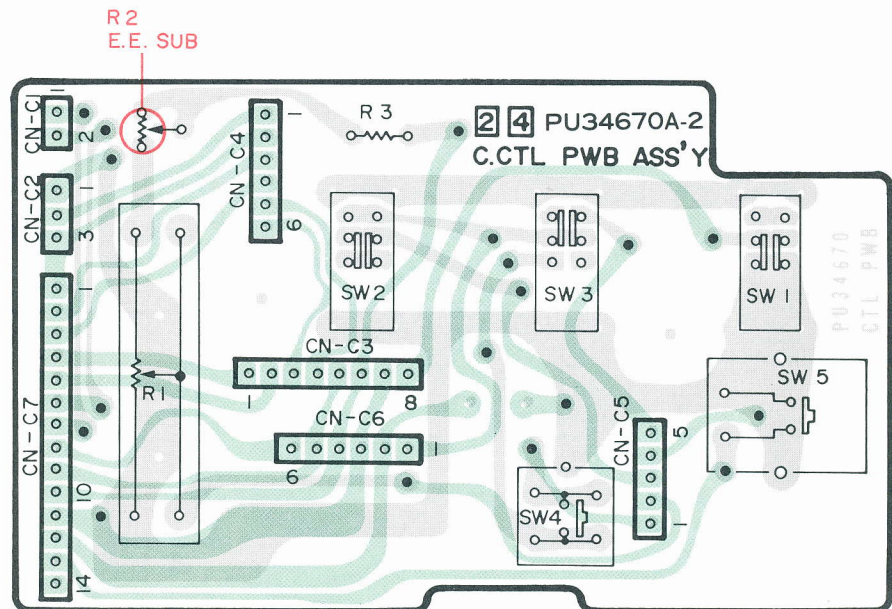

2 3 E-E und Anzeigeplatte
E-E and indicator PWB

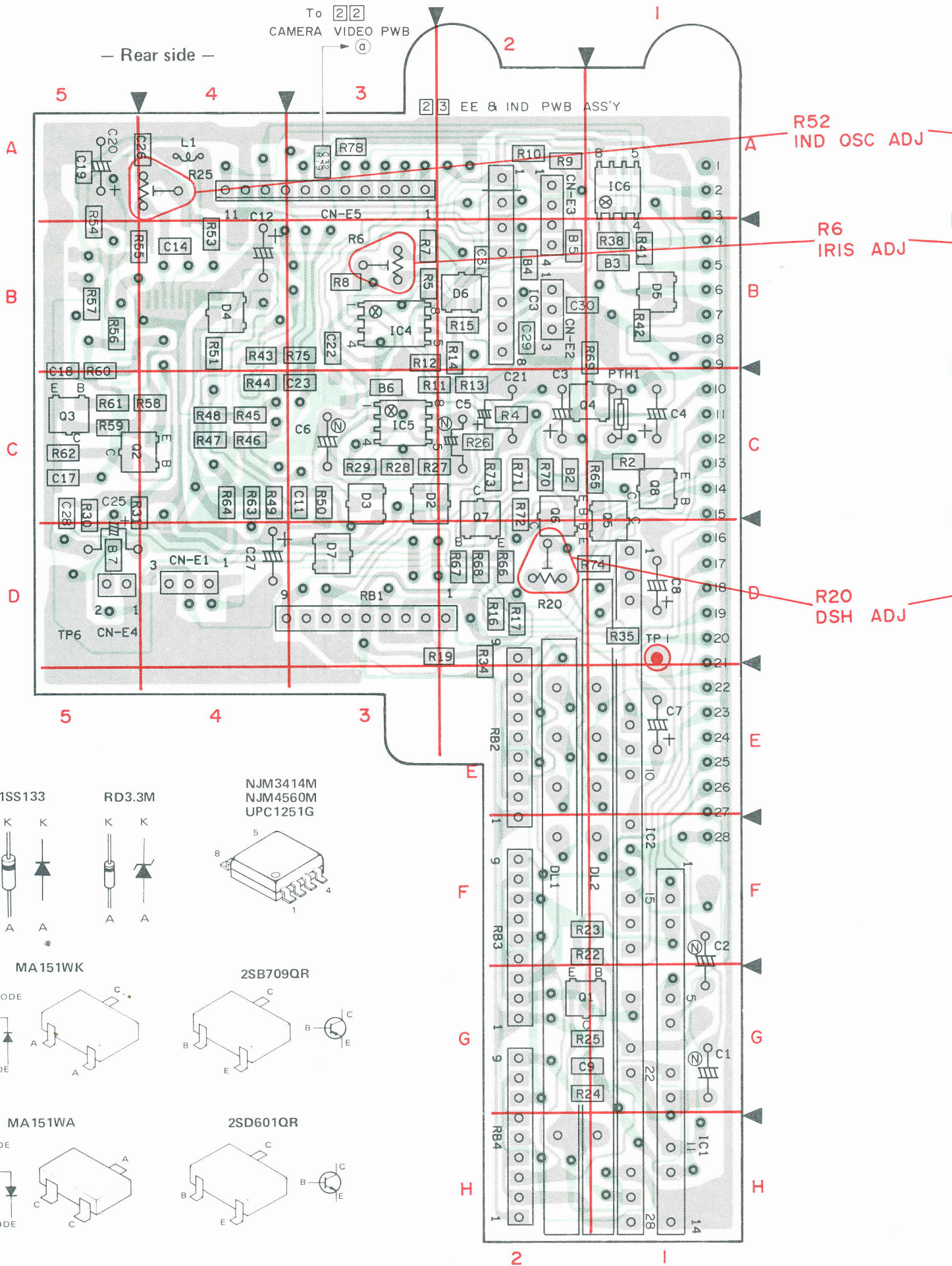

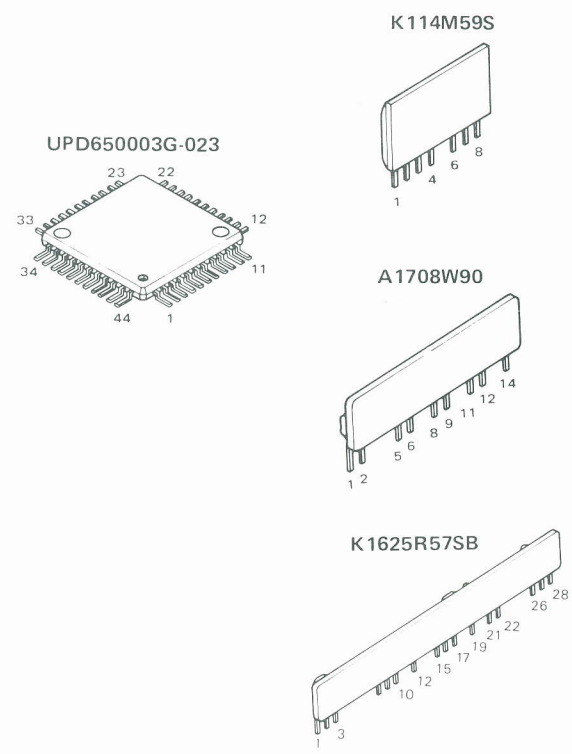
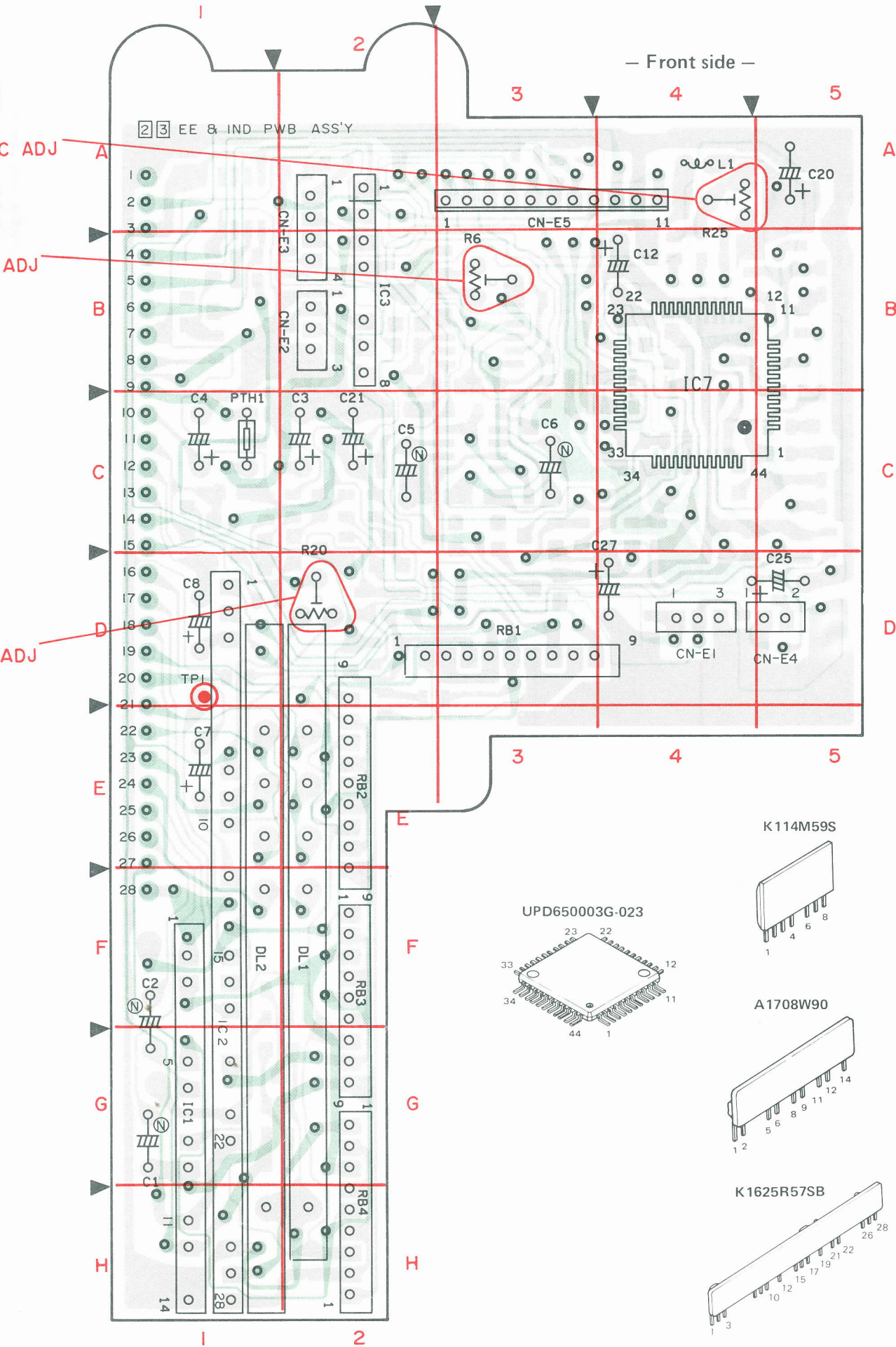



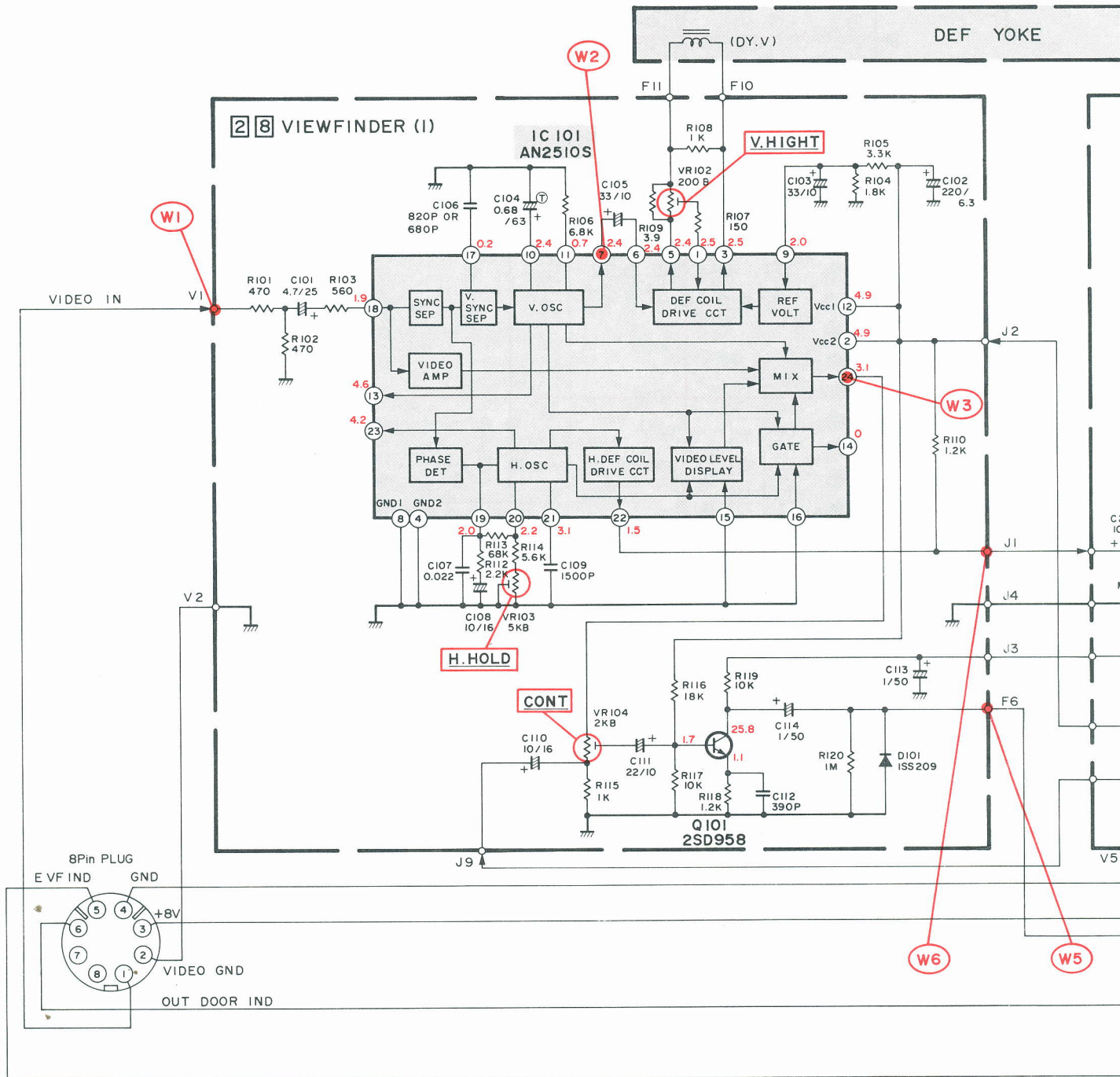

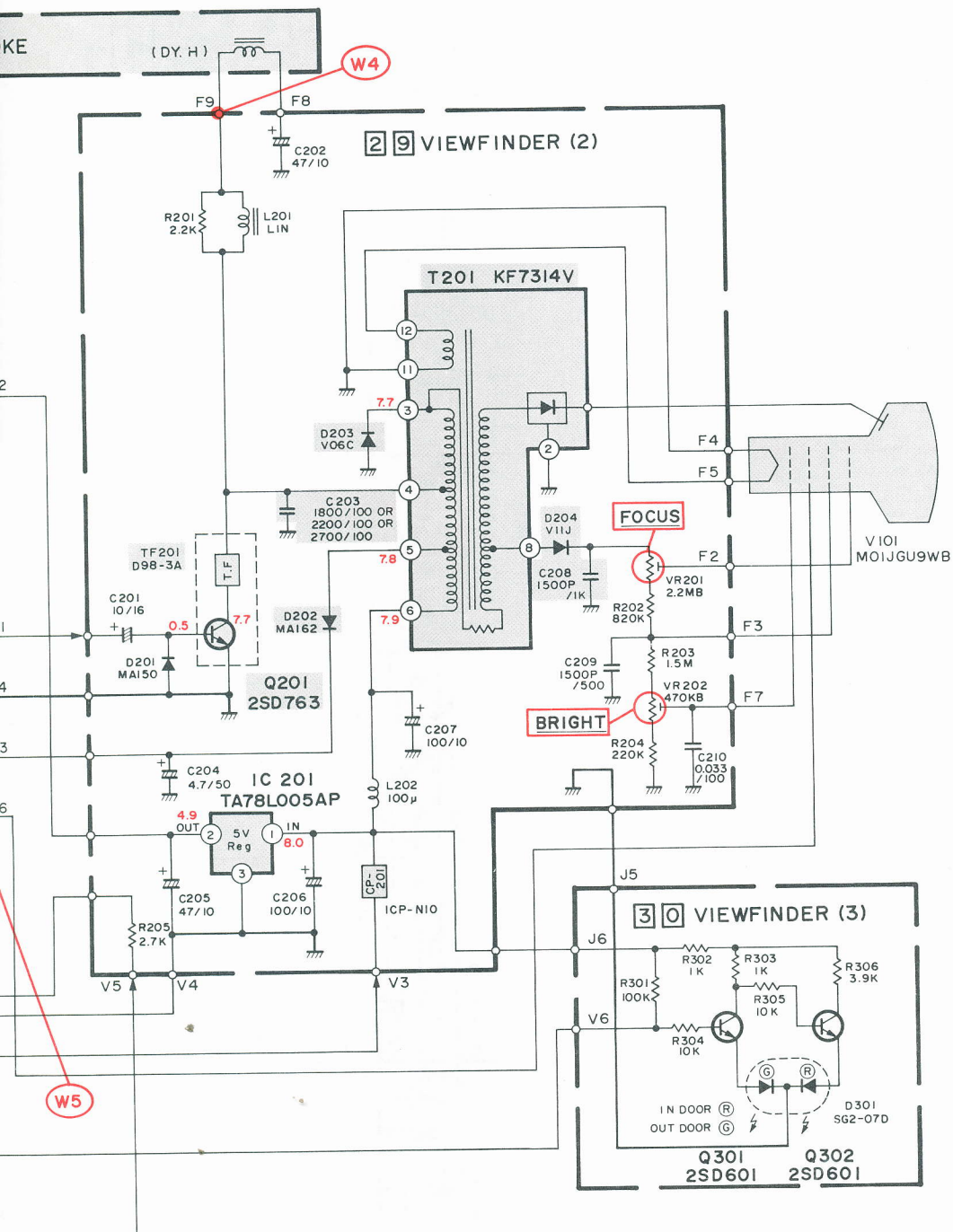
28, 29, 30 elektron. Sucher
Viewfinder

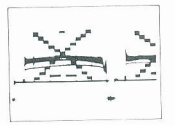

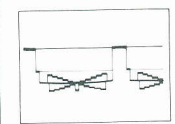

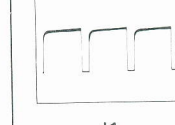
W1		V1 2.0 Vp-p
W2		IC101 (7) 3.0 Vp-p
W3		IC101 (24) 3.0 Vp-p
W4		F9 68 Vp-p
W5		F6 17 Vp-p
W6		J1 2.0 Vp-p

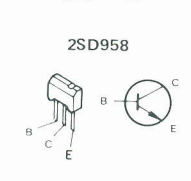
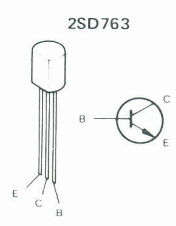
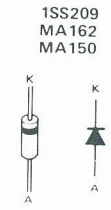
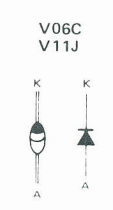
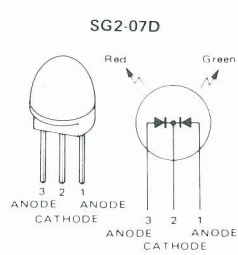
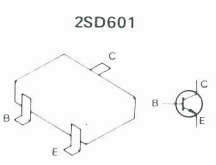
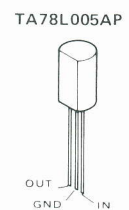
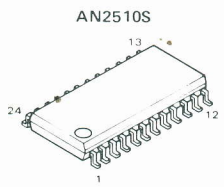
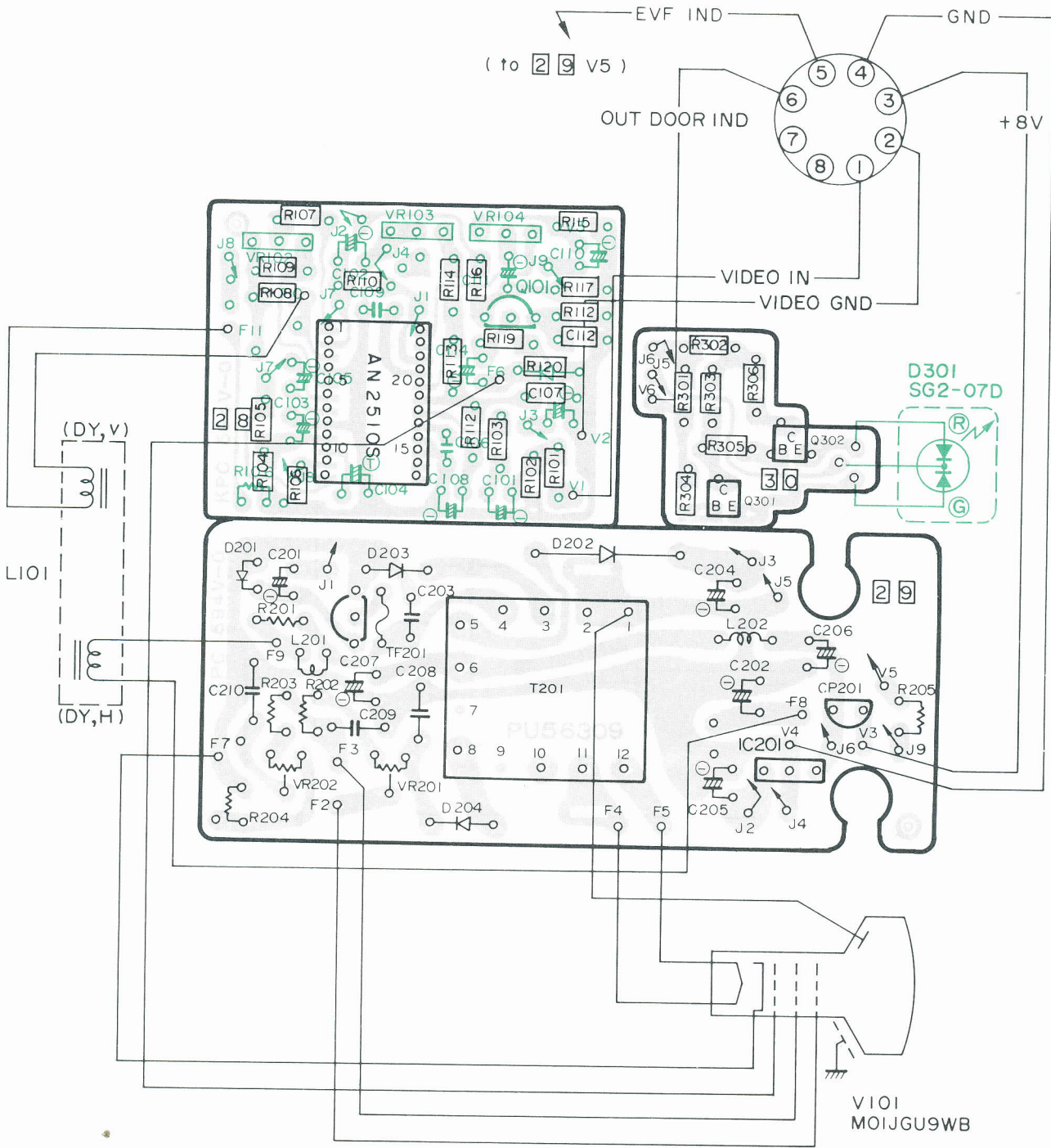



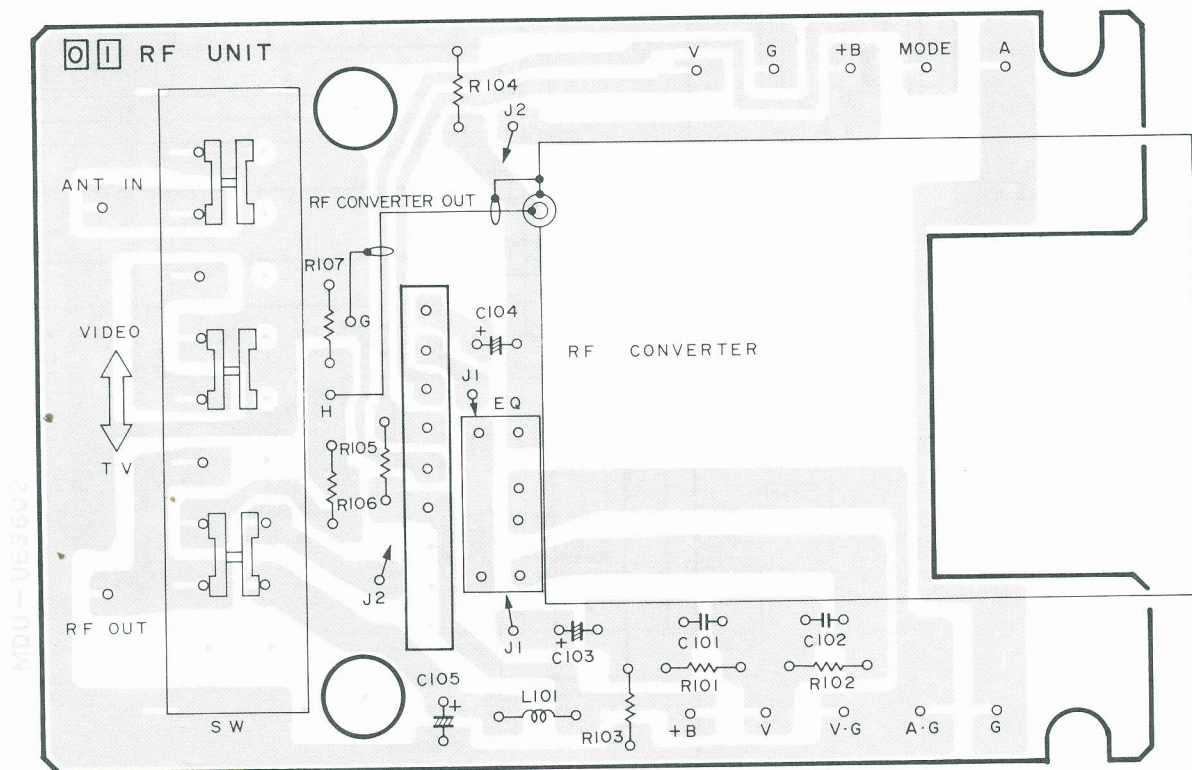
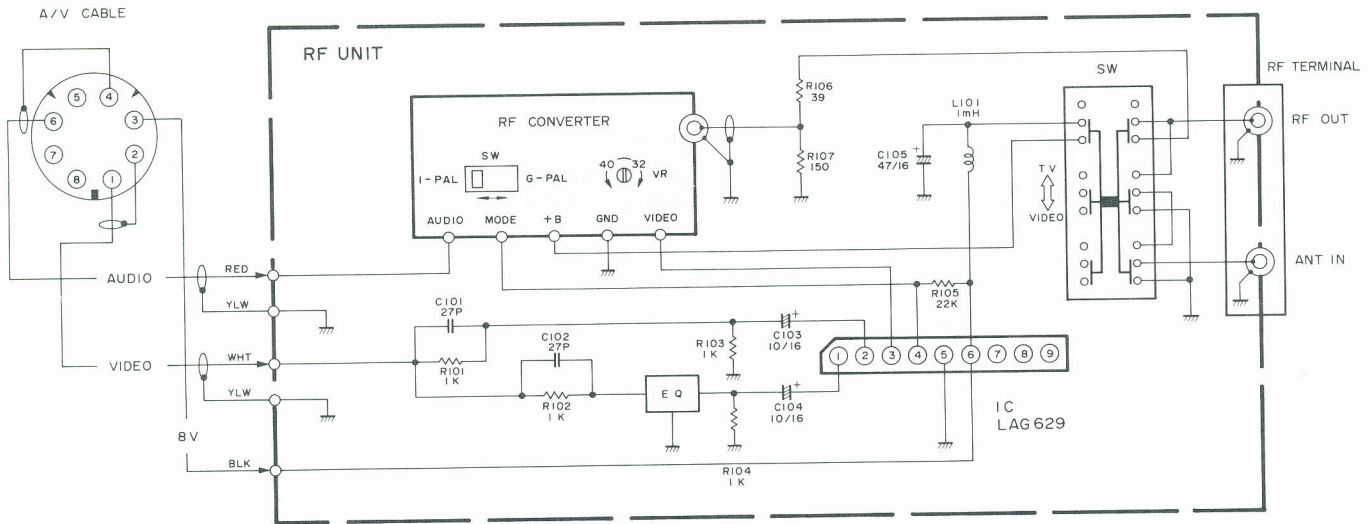

HF-Modulator RF-Unit



Netz- und Ladegerät AC power adaptor and battery charger

SCHEMATIC DIAGRAM

NOTES: Unless otherwise specified;

1. All resistance values are in ohms, 1/8 W.
 2. All inductance values are in μH .
 3. All capacitance values are in μF .
-  Electrolytic
  Ceramic
 Tantalum
  Mylar

4. Voltages are DC-measured with a digital voltmeter during STOP mode

- 1) Voltages during REC mode is shown in parentheses (); (SW3: VIDEO, SW4: OFF, SW5: OFF, Ground: CN6 pin 1)
 - 2) Voltages during CHG mode at nor road is shown in frame ;
(SW3: CHG, SW4: OFF, SW5: ON, Ground: CN6 pin 1)
5. Shaded () parts are critical for safety.
Replace only with specified parts numbers.

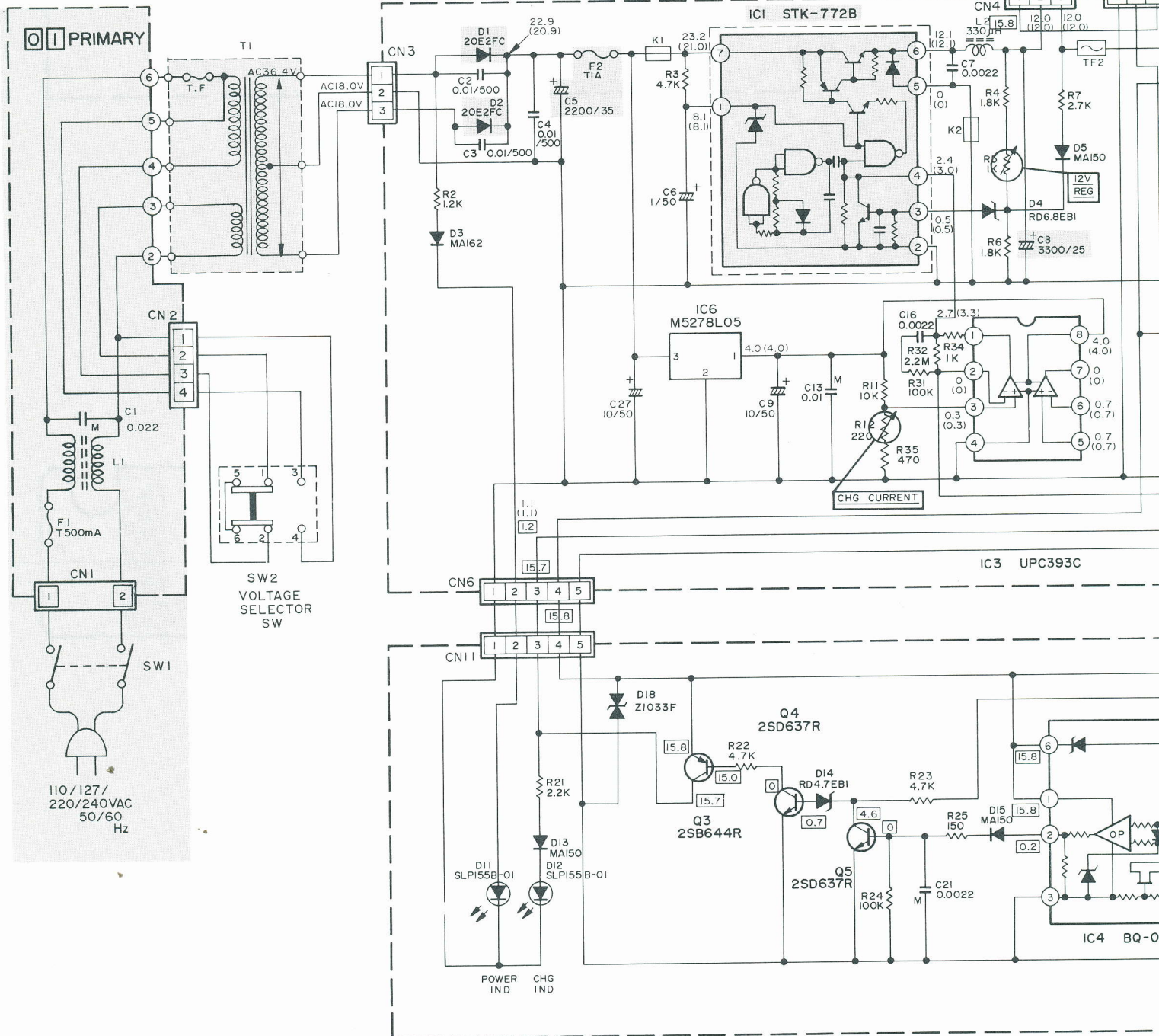

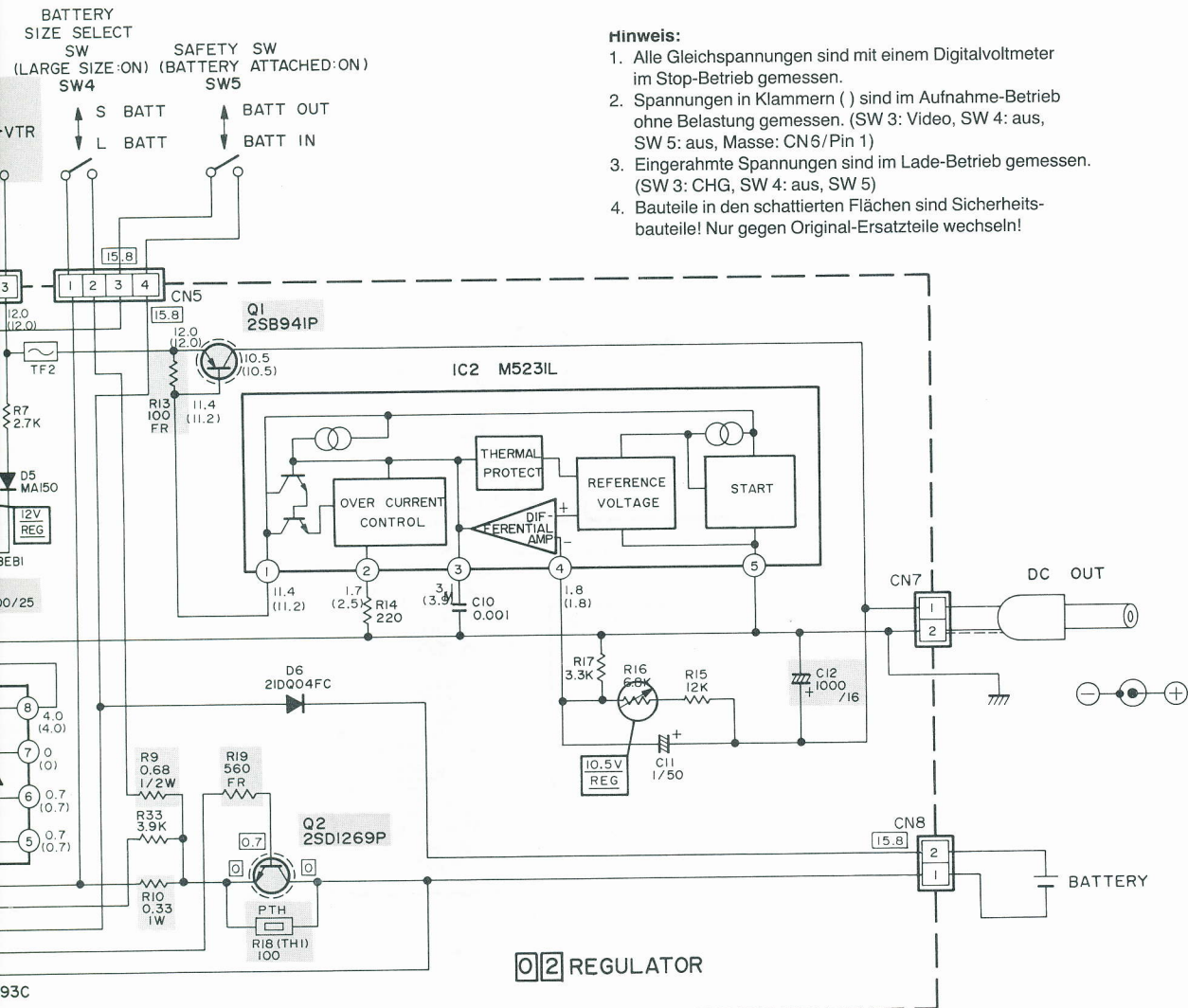

Hinweis:

1. Alle Gleichspannungen sind mit einem Digitalvoltmeter im Stop-Betrieb gemessen.
2. Spannungen in Klammern () sind im Aufnahme-Betrieb ohne Belastung gemessen. (SW 3: Video, SW 4: aus, SW 5: aus, Masse: CN6/Pin 1)
3. Eingerahmte Spannungen sind im Lade-Betrieb gemessen. (SW 3: CHG, SW 4: aus, SW 5)
4. Bauteile in den schattierten Flächen sind Sicherheitsbauteile! Nur gegen Original-Ersatzteile wechseln!

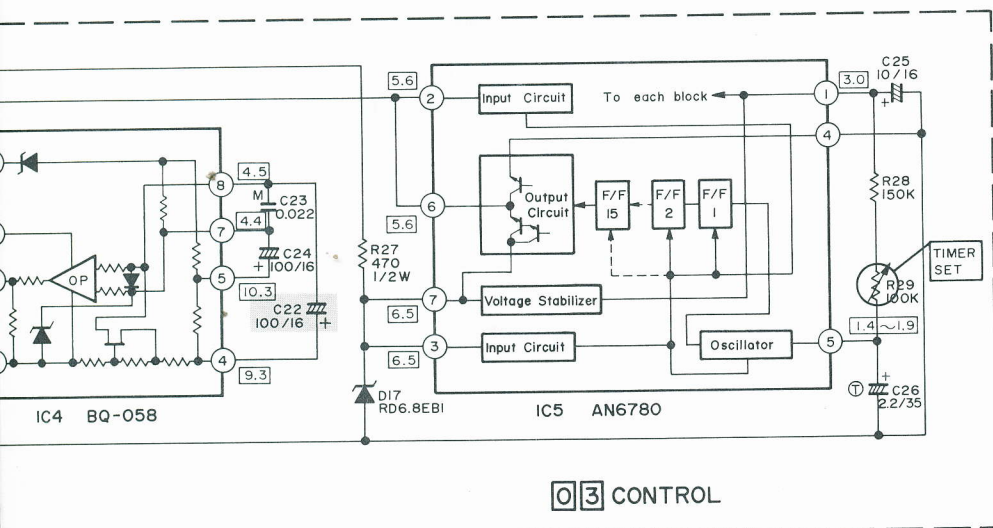

Netz- und Ladegerät AC power adaptor and battery charger

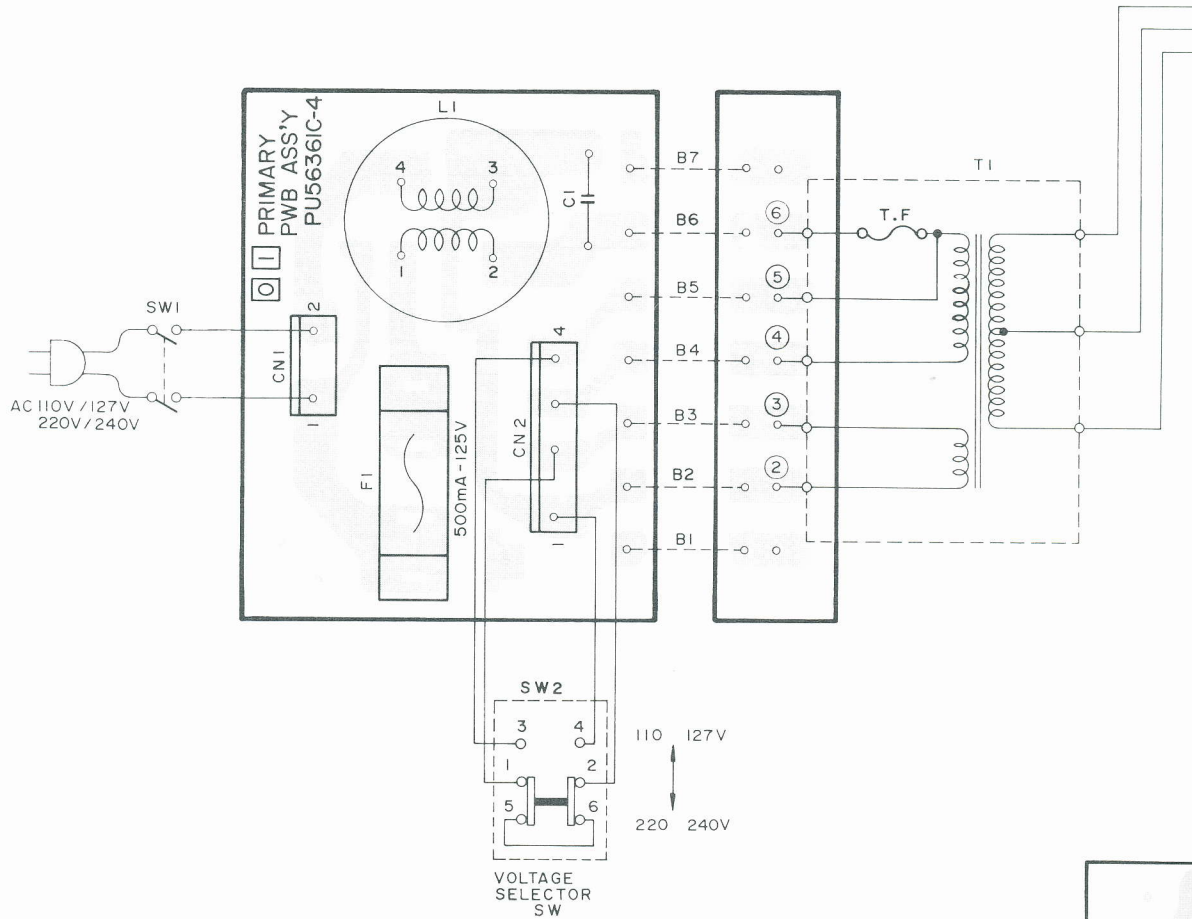

IC1 : STK-772B

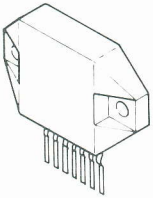

IC2: M5231L

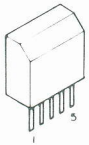

IC5: AN6780

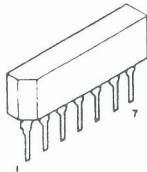

IC3: UPC393C



IC4 : BQ-058

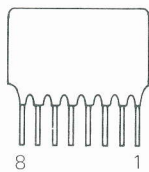

Q3: 2SB644R

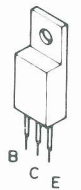

Q1: 2SB941P



Q4, Q5: 2SD637R



Q2: 2SD1269P

D4, D17 : RD6.8EB1
D14 : RD4.7EB1

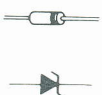

D18 : Z1033F

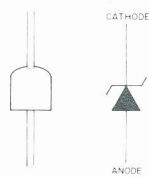

IC6 : M5278L05



D11, D12 : SLP155B-01

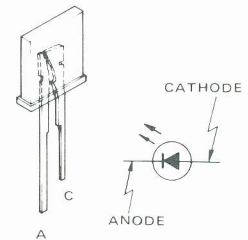

D1, D2 : 20E2FC
D3 : MA162
D6 : 21DQ04FC
D5, D13, D15, D18 : MA150

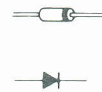

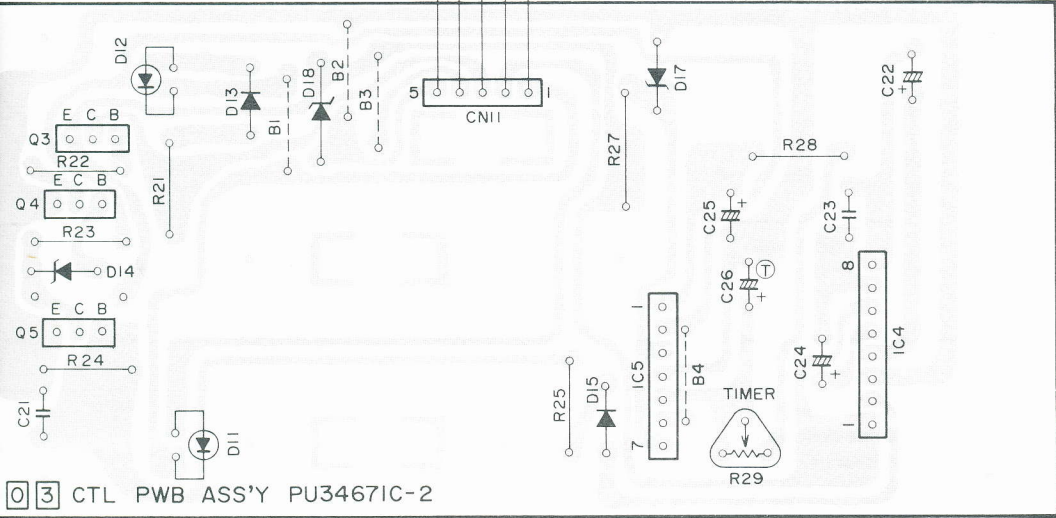
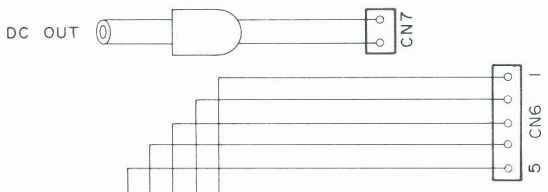
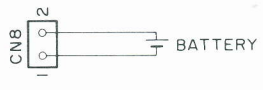
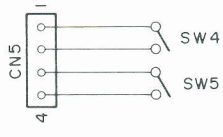
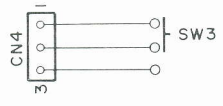
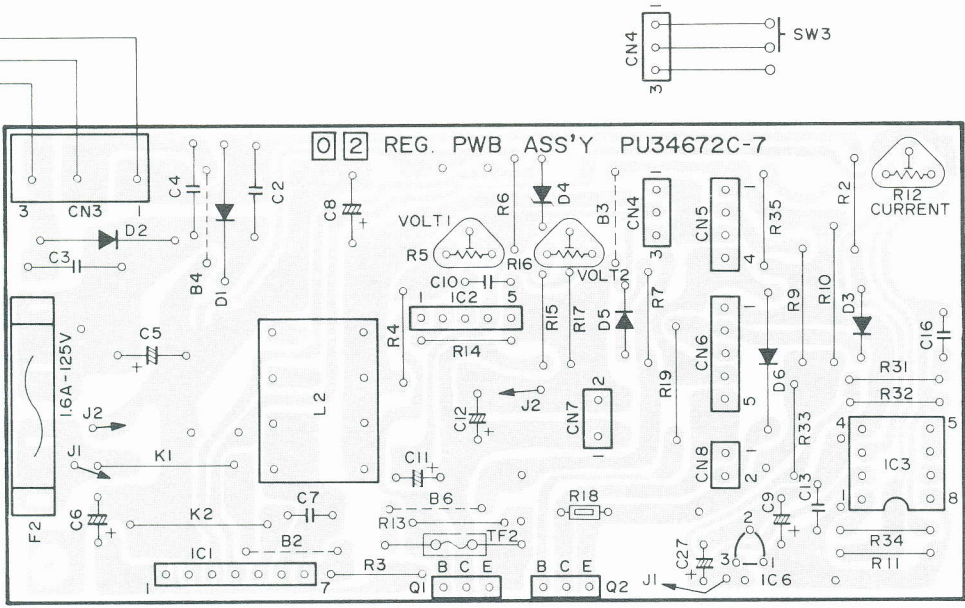

Y

Akku-Ladegerät Battery charger

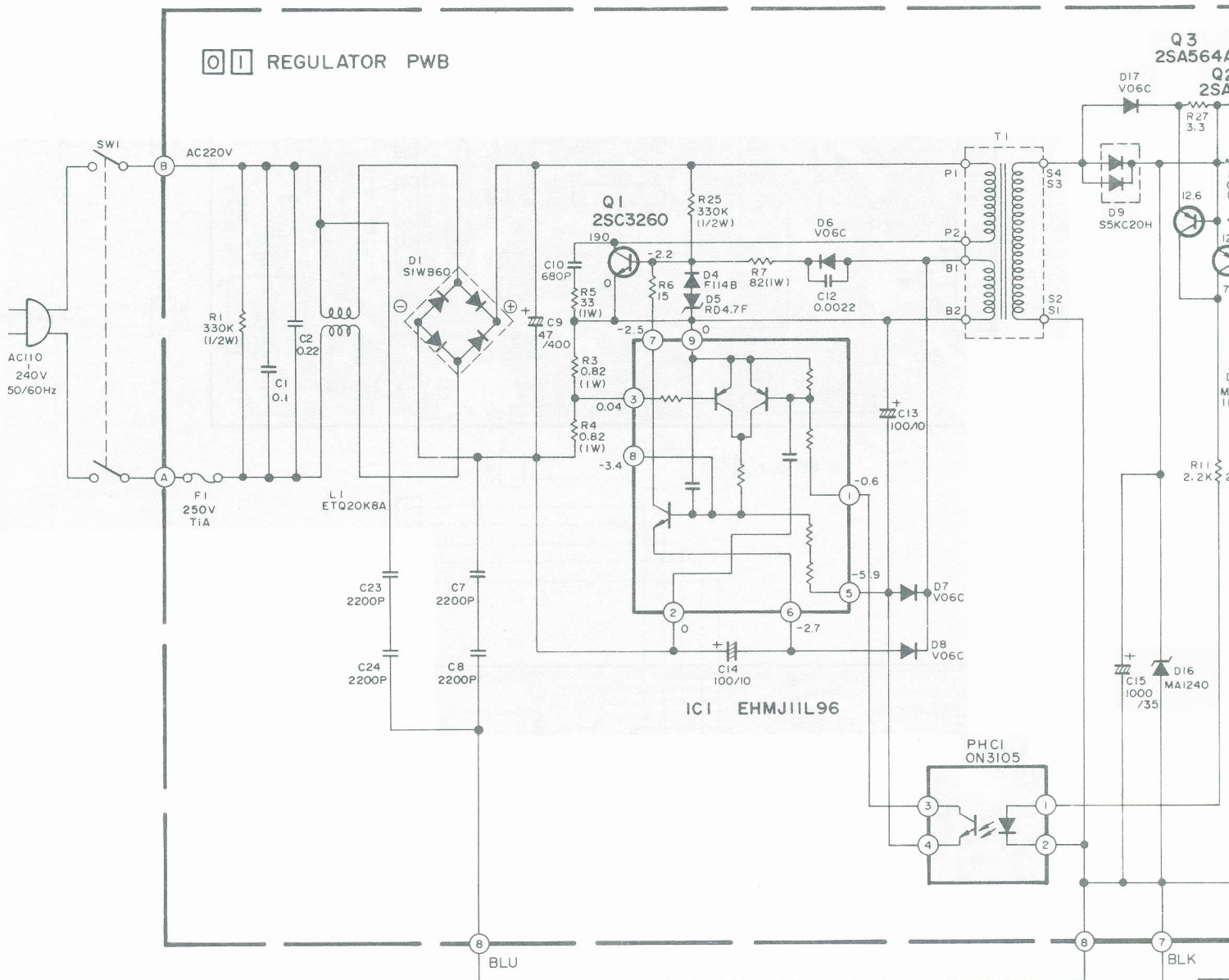

NOTE: Unless otherwise specified;

1. All resistance values are in ohms (1/4 W).
2. To measure voltages at T1 primary side, measure with D1 (⊖) grounded, at T1 secondary side, measure with PHC1 (Ⓜ) grounded.
3. Shaded () parts are critical for safety. Replace only with specified parts numbers.

IC2 : AN6780

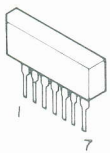

IC3 : BQ-058

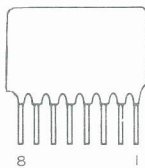

IC3 : J11L96

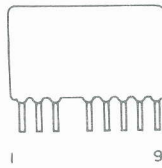

PHC : ON3105

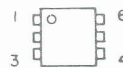

Q2, Q3 : 2SA564AR
Q4, Q5 : 2SB621AQ



Q7, Q8, Q9, Q10 : 2SC



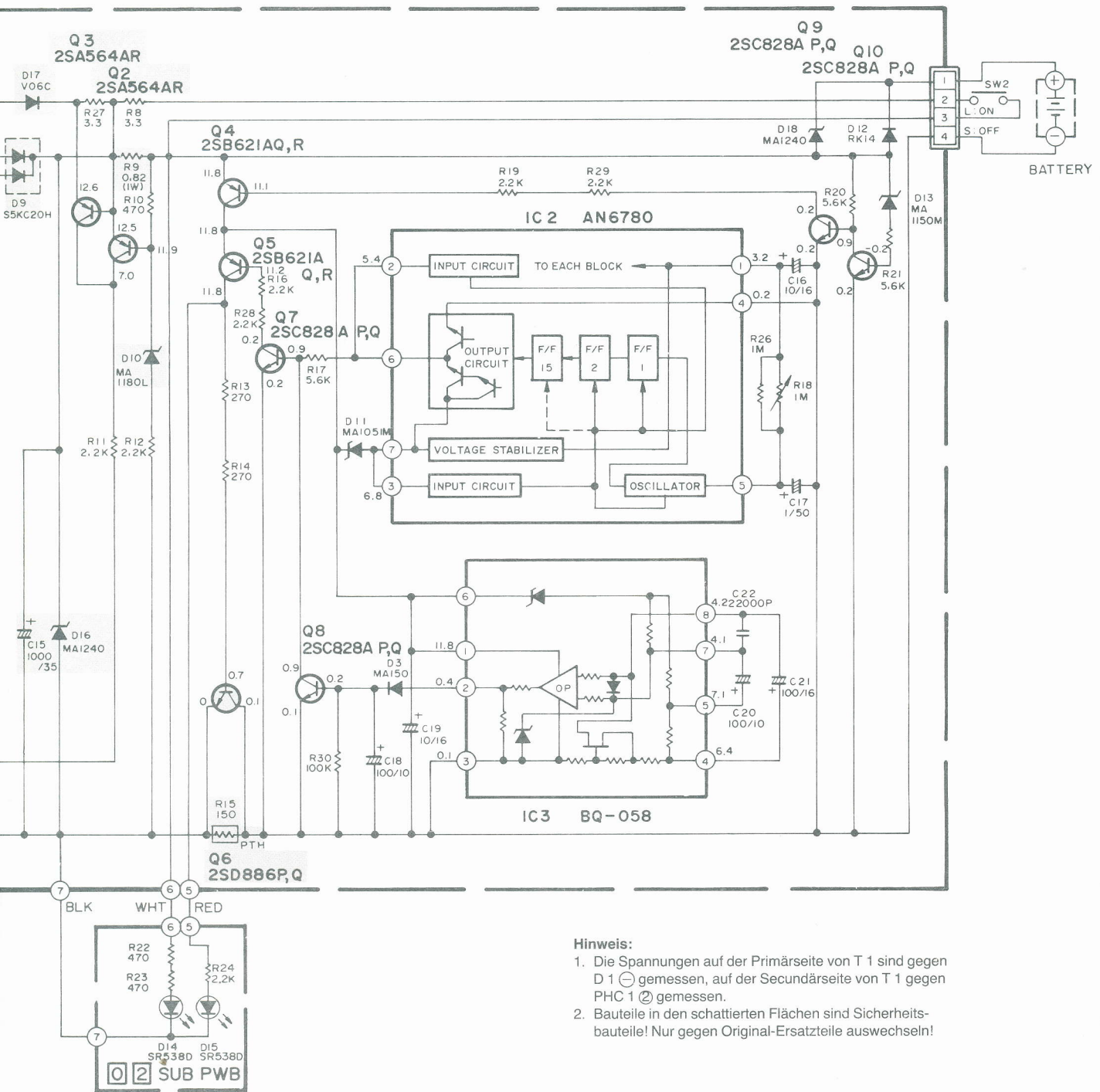

B, Q9, Q10 : 2SC828AP, Q

Q1 : 2SC3260

Q6 : 2SD886P, Q

D1 : S1WB60

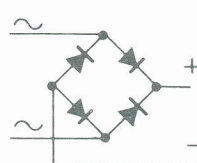
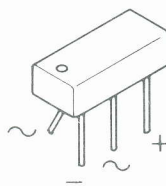
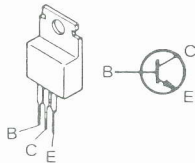
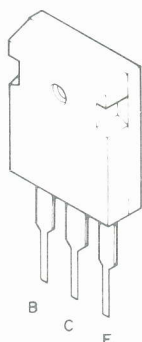

Akku-Ladegerät Battery charger

D6, D7, D8, D17 : V06C
D4 : F114B

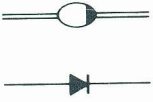

D9 : S5KC20H

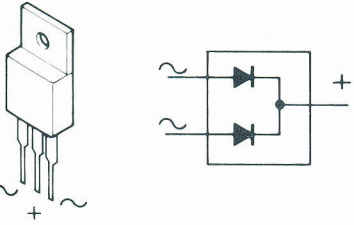

D3 : MA150

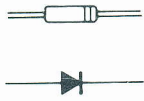

D12 : RK14

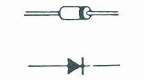

D10 : MA1180L
D13 : MA1150M
D16 : MA1240

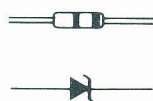

D11 : MA1051M

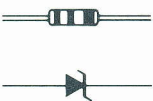

D14, D15 : SR538D

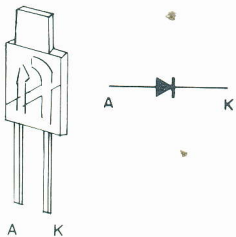

D5 : RD4.7F

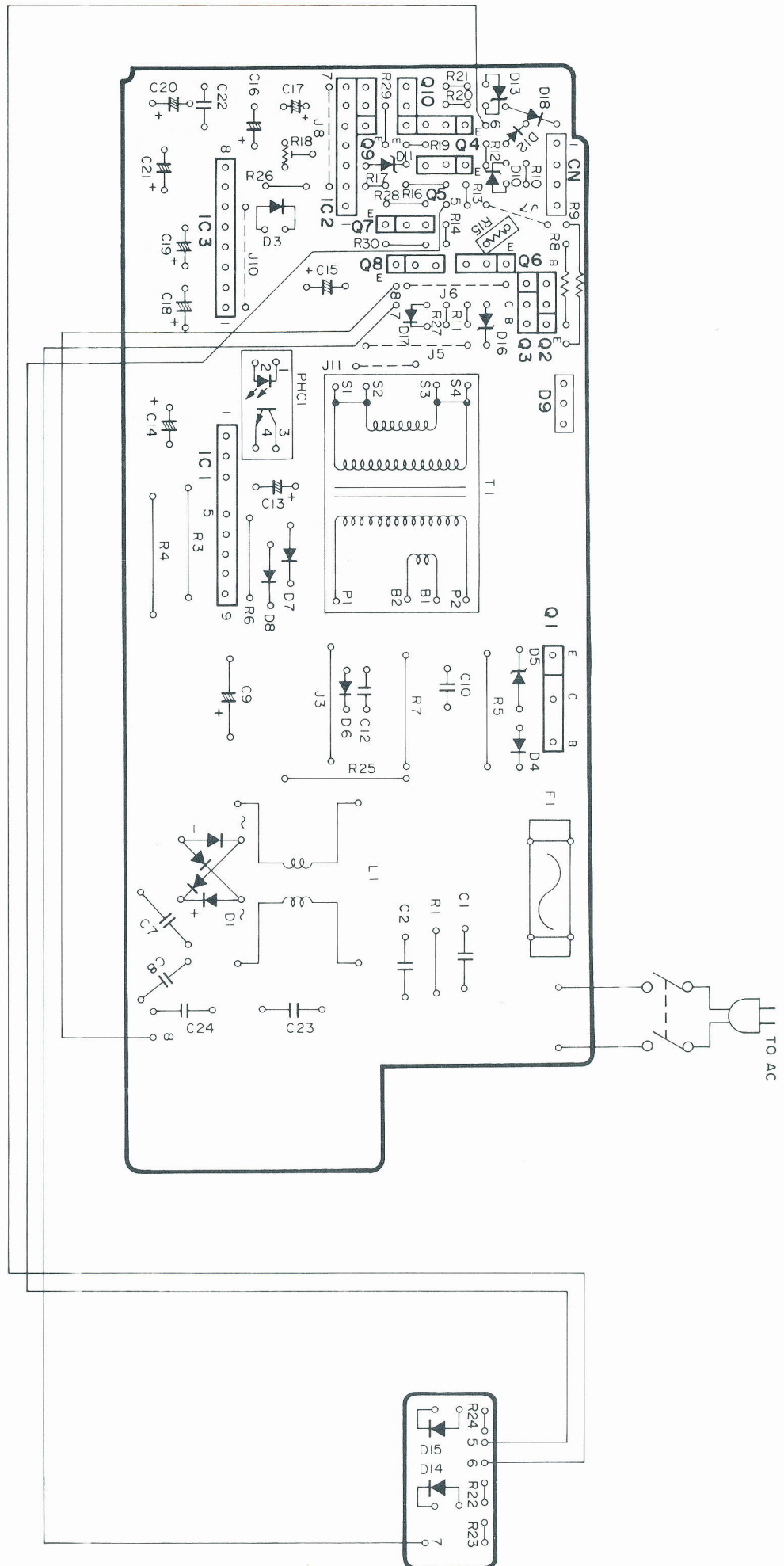

Bo
DC

10

Bordnetzkabel (Autobatterie-Adapter) DC-DC Converter

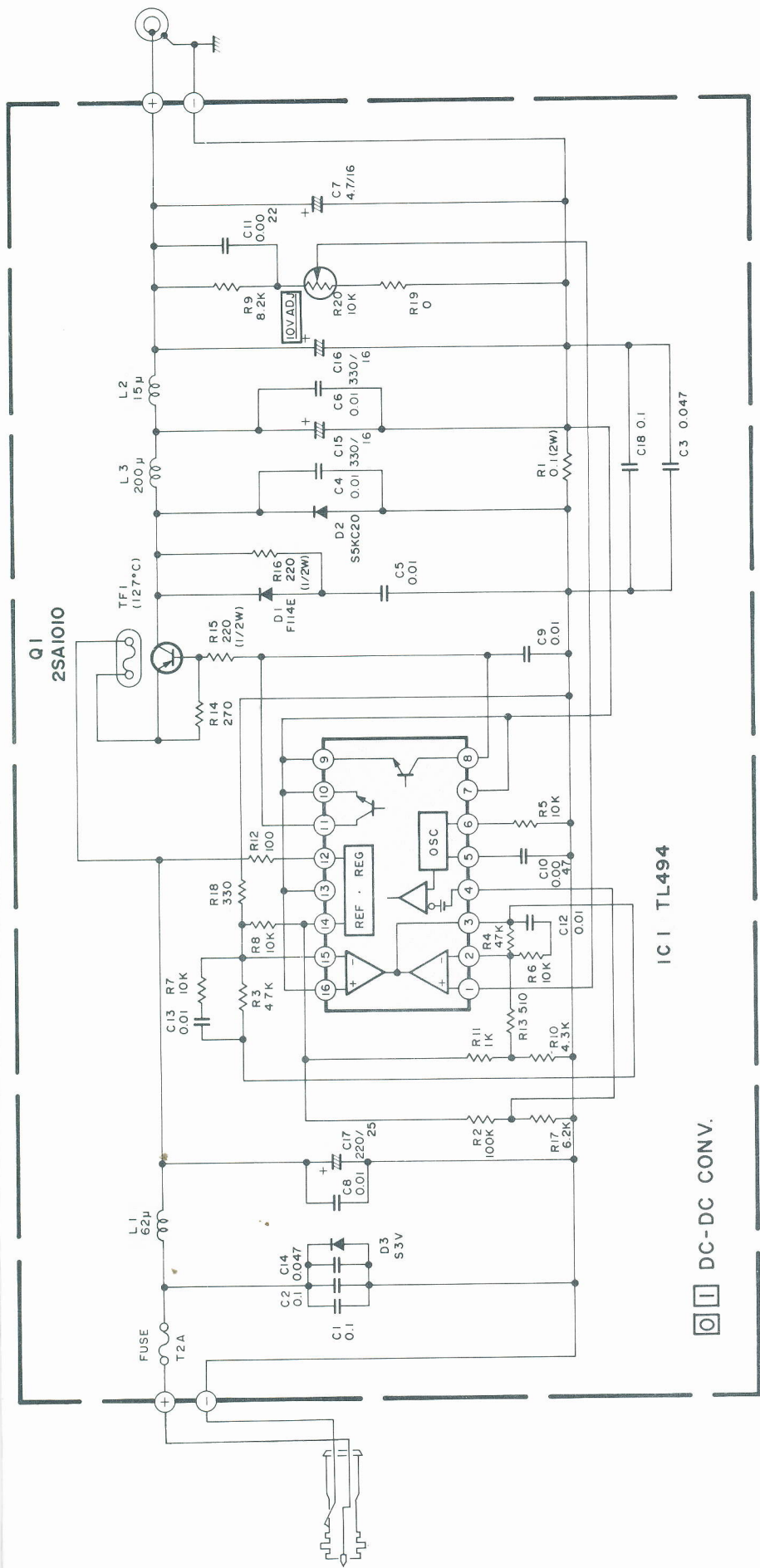

Hinweis:
Bauteile in den schattierten
Flächen sind Sicherheitsbauteile!
Nur gegen Originalteile
auswechseln!

- NOTES:** Unless otherwise specified.
1. All resistance values are in ohms.
 2. All inductance values are in μ H.
 3. All capacitance values are in μ F.

- : Chip capacitor
- : Electrolytic capacitor
- : Non-polar capacitor
- : Tantalum capacitor
- : Polypropylene capacitor
- : Mylar capacitor

4. Shaded () parts are critical for safety.
Replace only with specified aprt numbers.